



**PROMOFOLDER**

**01/10/2024 - 31/03/2025**

## NIEUWIGHEDEN

Artikel	Pagina
TW002GZ	9
HM004GZ01	14
DK0227Z201	16
CE003GZ02	19
CE004GZ	19
TM001GZ02	21
TM001GZ03	21
DK0228G201	22
RP001GZ02	25
BO001CGZ	27
BO002CGZ	27
BO003CGZ	27
BO004CGZ	27
BO005CGZ	27
BO006CGZ	27
DK0114G205	28
DFR453ZJ	53
DFR552ZJ	53
DRT52Z	54
DTC100ZK	64
DTC101ZK	64
DTC102ZK	64
DTC103ZK	64
DLX2394J	67
DLX2507T3J	68
DLX4183T3J	68
DLX7030T3J	68
MR014GZ	82
DP4021	100
9558HPGY	102
9565HRZ	103
9565CVR	103
UC021GZ	G5 (144)
UC022GZ	G5 (144)
UC023GZ	G5 (144)
UC024GZ	G5 (144)
UC025GZ	G5 (144)
UC026GZ	G5 (144)
DHW180Z	G10 (139)
UB004CZ	G13 (136)
UH020GZ	G20 (129)
UH021GZ	G20 (129)

## COMBOPACKS

Artikel	Pagina
Combopacks XGT	16, 22, 28-29
Combopacks LXT	67-69
Combopacks CXT	72
Combopacks cleaning	87
Combopacks slijpers	106
Combopacks zaagmachines	111
Combopacks tuin	131

## PROMOTIES

Artikel	Promotie	Pagina
DF001GM201	E-05337 + E-15154	8
HP001GM201	E-05337 + E-15154	8
TD001GZ02	DEAML006G	8
TW007GD201	E-16586	9
CE001GZ	E-12996	18
LS002GZ01	DEBWST06	24
LS004GZ01	DEBWST06	24
LS003GZ01	DEBWST06	24
DK0124G201	BL4025	28
DK0125G301	BL4040	28
DK0126G401	BL4040 + DC40RA	29
DK0128G601	2X BL4040 + DC40RA	29
191L77-9	STUNTPRIJS	31
1911V6-0	STUNTPRIJS	31
DDF453RF3J	E-05599	40
DDF485RTJ	STUNTPRIJS	41
DDF484RTE	STUNTPRIJS	41
DHP485RFJ	STUNTPRIJS	41

## PROMOTIES

DHP484RTJ	STUNTPRIJS	41
DHR243RTJ	BL1850B	42
DHS680RTJ	BL1850B	50
DCE090ZX1	E-03006-25	51
DGA506RTJ	BL1850B	60
DGA508RTJ	BL1850B	60
DTR180ZJ	191A57-9	63
DGA506T1J	D-18770-10	69
DGA508T1J	D-18770-10	69
CLX2285AX2	DEAML103	72
MR014GZ	PGC120040	82
DMR056	PGC120040	82
MR004GZ	PGC120040	82
MR007GZ	PGC120040	82
DCL182Z	199491-1	86
DCL284FZB	191D71-3	86
HR2630TX12	D-42444	96
HR2631FT12	D-42444	96
HR2651TX12	D-42444	96
HR4013C	P-52445	97
HR4511C	P-52445	97
HR5212C	P-52445	97
HM0871C	E-20236	98
HM1812	D-54972	99
GA5092X01	195354-9	104
GA5090X01	195354-9	104
GA5091X01	195354-9	104
GA5095X01	195354-9	104
GA5094	195354-9	104
GA5093X01	195354-9	104
LS1019L	DEBWST06	113
LS1219L	DEBWST06	113
SKR200Z	P-81315	117
SK105DZ	BL1021B + DC10SB	118
SK105GDZ	BL1021B + DC10SB	118
SK106GDZ	BL1021B + DC10SB	118
SK10GDZ	197658-5	118
SK20GDZ	197658-5	118
SK40GDZ	197658-5	118
SK209GDZ	197658-5	118
SK312GDZ	197658-5	118
SK700DZ	197658-5	119
SK700GDZ	197658-5	119
DUC256Z001	E-08458	G3 (146)
DUC356Z001	E-08458	G3 (146)
DUC406Z001	E-08458	G3 (146)
DUC306Z001	E-08458	G3 (146)
LM001GZ	BL4040	G24 (125)
LM002GZ	BL4040	G24 (125)
UM600DSAEX	831253-8	G18 (131)
DUM604RFEX	831253-8	G18 (131)
DUM111SYX	831253-8	G18 (131)
DCU180Z	199009-8	G17 (132)



XGT - 40Vmax

6



LXT - 18 V / 2 x 18 V

36



CXT - 12Vmax

72



Outdoor

78



Cleaning

86



Elektrisch

96



Lasers

117



Tuin

110





# Makita Service

Makita staat bekend om zijn expertise, kwaliteit en service...

Maar wat maakt de service van Makita nu zo uniek? Wij vroegen het aan Yves (supervisor) en Johan (teamleader) van de technische dienst.

## Help, mijn machine is stuk!

"Als er iets aan de hand is met je machine, kan je je toestel best binnenbrengen bij een erkende Makitadealer. Die kan je vinden via de dealerlocator op onze website. Sommige dealers zijn servicedealers en doen de reparaties zelf, de anderen sturen de toestellen op naar ons. Die toestellen komen dan binnen op de hersteldienst bij Makita Kortenberg of Charleroi. Per jaar repareren wij zo'n 30.000 machines."

## Hoelang duurt een reparatie?

"Wij streven naar een reparatie binnen de 24 tot 48 uur. We zijn sowieso al snel omdat de verzending van de dealer naar onze magazijnen vlotter verloopt dan wanneer de herstelling in het buitenland gebeurt. Wanneer een machine binnenkomt bekijken we het vrijwel meteen. Het Makitagereedschap is ook zo gemaakt dat het gemakkelijk te herstellen is. Alles is bijvoorbeeld met dezelfde schroeven vastgemaakt. Veel servicedealers zeggen dat ze het liefst aan een Makita sleutelen."

"Soms kan een herstelling langer duren dan verwacht omdat we een onderdeel moeten bijbestellen. Dat gebeurt niet zo heel vaak, aangezien wij 185.107 onderdelen in onze magazijnen hebben klaarliggen. Wij houden de stukken voor machines soms jaren bij, we hebben zelfs nog stukken uit 1980."

## Hoe werkt de garantie bij Makita?

"Op gebied van garantie hebben particulieren twee jaar garantie en professionals één jaar, dat is wettelijk bepaald. Wanneer je het toestel registreert via MyMakita op onze website kan je wel tot drie jaar garantie krijgen, ongeacht of je een professional of een particulier bent."

## Wat als het toestel niet (meer) onder garantie is?

"Je kan je toestel nog altijd laten maken. Vanaf de reparatie duurder is dan 45% van de nieuwprijs maken wij een bestek op. Dan geven wij dit door via de dealer."

"We krijgen wel vaker machines binnen die niet meer onder garantie zijn, zo deed ik overlaatst nog een reparatie voor een klopboor uit 1982. Sommige machines zijn zo oud dat er zelfs geen datum opstaat. Machines uit 2000 komen nog heel vaak binnen, wij stellen dan wel eerst een voorstel voor de klant op, zeker als de machine al meer dan 20 jaar oud is."

"Je kan trouwens ook het onderhoud van je machines laten doen bij Makita, dat kunnen klanten aanvragen bij hun dealer. Wanneer we het toestel bekijken en we vinden dat geen onderhoud nodig is, doen we dat ook niet."



20 MEDEWERKERS



OP DE TECHNISCHE DIENST



30.000+  
herstellingen per jaar

185.107

onderdelen in de magazijnen



**Makita blijft de  
Rolls Royce van  
het elektrisch  
gereedschap**

#### Wat maakt de service van Makita uniek?

Johan: "We werken heel snel door onze eigen herstellingsdiensten in België. Daardoor is die prijs-kwaliteit uitstekend, de klant betaalt niet veel voor goede herstellingen."

Yves: "Het is eigenlijk bijna ambachtelijk. We analyseren elk toestel grondig, herstellen wat kapot is en werken niet in modules. Tot het kleinste vijsje kan bij ons vervangen worden. Dat is duurzamer én goedkoper voor de klant."

"Bovendien zijn wij telefonisch bereikbaar. Klanten kunnen hun verhaal doen, zo weten wij ook beter hoe we het toestel moeten repareren. Op die manier kunnen wij klanten op de hoogte houden van hun herstelling en een bestek opmaken. Dan kan de klant zelf nog beslissen of die de herstelling wil laten uitvoeren voor de voorgestelde prijs of het wil omruilen voor een vergelijkbaar toestel met 10% korting. Ook de servicedealers kunnen ons altijd bereiken als er iets niet lukt met hun herstelling. Die servicedealers krijgen trouwens ook hun opleiding door ons, bij Makita. Op die manier geven we de beste ondersteuning aan dealers en eindklanten."

Yves: "Als je het mij vraagt, de service van Makita is formidabel en gebouwd op een team." Een team met veel ervaring. Alle knowhow zit dan ook onder één dak bij Makita: onze customer service en technische dienst kunnen met elkaar in gesprek gaan en dat is een meerwaarde. U weet waarover u praat. Wij ook.



#### GEKSTE MACHINE

Johan: "We kregen ongeveer een jaar geleden een tandvrij voor paarden binnen. Paarden hebben kiezen die blijven groeien en dan bijgevoild moeten worden. Lang geleden verkochten we dit bij Makita en soms duikt er nog eens eentje op voor een reparatie."

#### TIPS

"Jouw machines graag zien en de handleiding lezen..."

#### MAKITA IN ÉÉN ZIN

"Makita blijft de Rolls Royce van het elektrisch gereedschap."

**XGT**

# 40V **Li-ion** max



## Next Generation Technology

XGT is een nieuw platform met specifieke machines, accu's en laders. De combinatie van Makita's bewezen motortechnologie, geavanceerde elektronische sturing en kwalitatieve 40Vmax-batterijen biedt een geweldig alternatief voor de meest veeleisende gebruiker. Het XGT-platform vult het bestaande CXT- en LXT platform aan maar vervangt deze niet. Het is de volgende, logische stap naar een snoerloze toekomst en zorgt voor een oplossing op accu voor de zwaarste toepassingen.

## Digitale communicatie

Op het XGT-platform kunnen de machines en accu's nu ook onderling digitaal communiceren via geïntegreerde elektronica. Dat resulteert in een perfect energiemangement, optimale prestaties en bovendien een effectieve bescherming van alle componenten bij extreme belasting.

## Optimaal laden

Digitaal geoptimaliseerd laadtraject met twee ventilatoren voor een perfecte temperatuurcontrole en continue actieve bijsturing van het laadtraject. Het resultaat zijn nog snellere laadtijden en een langere levensduur van de batterijen.





# De nieuwste innovatie in accugereedschap



**KRACHTIG**



**TOEKOMST-  
GERICHT**



**INTELLIGENT**



**BETROUW-  
BAAR**

## MAKITA ACCUPLATFORMEN

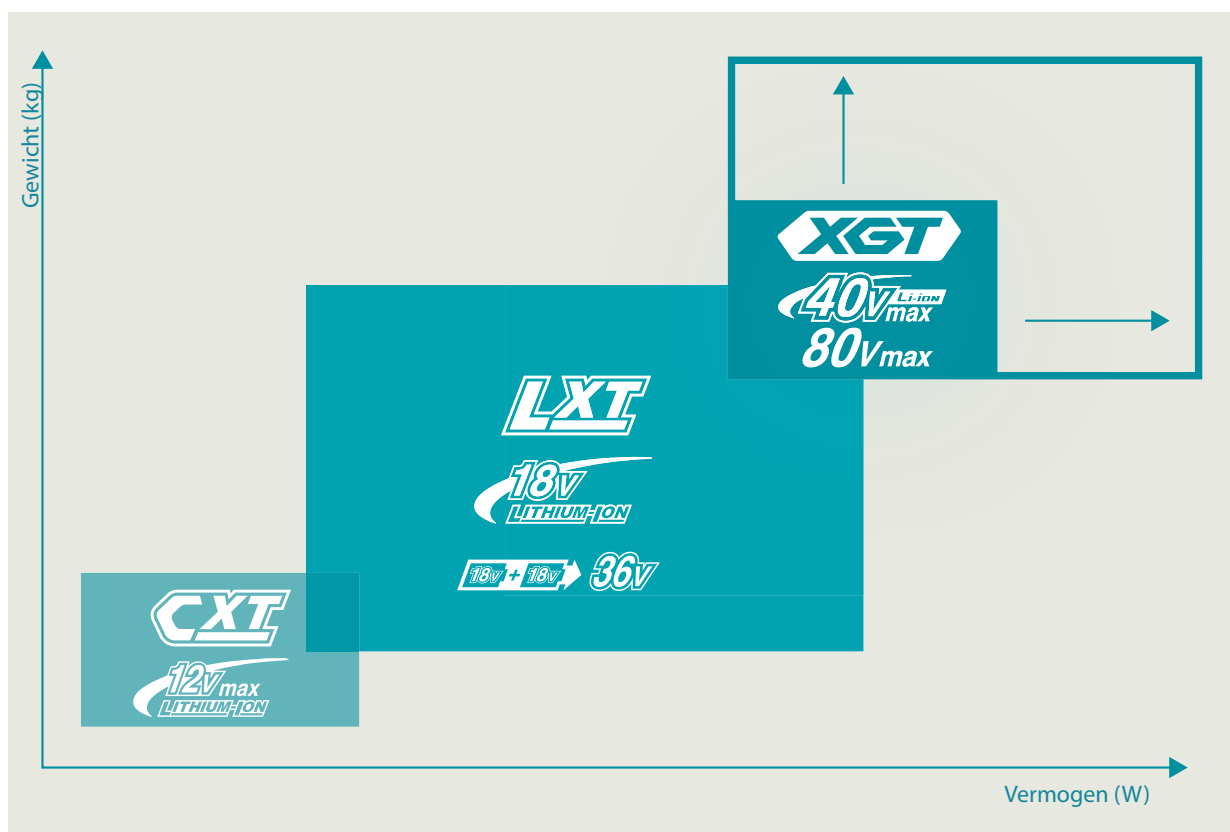

Het CXT accuplatform is de basis voor het 10,8V (12Vmax) accugereedschap van Makita. Makita-accu's uit het CXT-systeem zijn verkrijgbaar met een capaciteit tot 5,0 Ah (54 Wh). CXT accu's vormen een ideale combinatie met kleinere machines die vooral compact en licht moeten zijn (bijvoorbeeld voor het werken op moeilijk bereikbare plaatsen).



Het LXT platform heeft zich ontwikkeld tot het systeem met het grootste gamma compatibele machines. LXT accu's zijn verkrijgbaar met een capaciteit tot 6,0 Ah (108 Wh). Met de LXT-serie biedt Makita een accu voor ruim 420 machines en tuingereedschap. In het geval van 2x 18V machines worden twee LXT accu's gecombineerd voor nog meer vermogen en/of een grotere autonomie. In dit segment vindt de gebruiker professionele tools voor (bijna) elke toepassing.



De XGT-klasse met eigen machines, accu's en lader vormt een aanvulling op de beproefde CXT- en LXT-plattform. De XGT-accu's zijn zeer robuust en ontworpen voor gebruik in zware omstandigheden. De 2x 40Vmax machines gebruiken twee XGT accu's voor nog meer vermogen en/of autonomie. XGT accu's zijn verkrijgbaar met een capaciteit tot 8,0 Ah (288 Wh). Het XGT systeem biedt de hoogste prestaties en snelste laadtijden hetgeen ook nieuwe toepassingsgebieden in de bouw, industrie, facility management en groenbeheer mogelijk maakt.





DF002GD201

HP001GM201



**41 elektronische koppelinstellingen**  
Voor een groter instelbereik en grotere nauwkeurigheid.



**Active Feedback sensing Technology**  
Schakelt de machine uit bij een plotse zwenkbeweging.



DF001GM201 & HP001GM201:  
gratis gereedschapsriem E-05337 + holster E-15154

## HP001G / DF001G

- Maximaal koppel tot 140 Nm
- Tot 35 % hogere snelheid
- Bestand tegen continu werken onder hoge belasting

	DF001GZ01	DF001GM201	DF002GZ01	DF002GD201	HP001GZ01	HP001GM201	HP002GZ01	HP002GD201
Spanning	36 V (40Vmax)	36 V (40Vmax)	36 V (40Vmax)	36 V (40Vmax)	36 V (40Vmax)	36 V (40Vmax)	36 V (40Vmax)	36 V (40Vmax)
Bijgeleverde accu's	0	2 x BL4040	0	2 x BL4025	0	2 x BL4040	0	2 x BL4025
Lader	-	DC40RA	-	DC40RA	-	DC40RA	-	DC40RA
Max. koppel zacht / hard	68 / 140 Nm	68 / 140 Nm	30 / 64 Nm	30 / 64 Nm	68 / 140 Nm	68 / 140 Nm	30 / 64 Nm	30 / 64 Nm
Boorkop	1,5 - 13 mm	1,5 - 13 mm	1,5 - 13 mm	1,5 - 13 mm	1,5 - 13 mm	1,5 - 13 mm	1,5 - 13 mm	1,5 - 13 mm
Klopboorfunctie	-	-	-	-	✓	✓	✓	✓
Gewicht	2,7 kg	2,7 kg	2,5 kg	2,5 kg	2,7 kg	2,7 kg	2,6 kg	2,6 kg
Prijs in €	excl. btw							
	incl. btw							

## 31-DELIGE SCHROEFBITSET IMPACT BLACK (E-22850)



**Bevat:**

- 25 mm bits: PH1 (1st), PH2 (3st), PH3 (1st), PZ1 (1st), PZ2 (3st), PZ3 (1st), T15 (1st), T20(2st), T25 (1st), T30 (1st)
- 50mm bits: PH2 (1st), PZ2 (1st), T15 (1st), T20 (1st), T25 (1st), T30 (1st)
- HSS-boren: diameter 2,5, 3,0, 3,5, 4,0, 4,5, 5,0
- Magnetische bithouder: 60 mm
- Magnetische krachtdop: 6 mm, 8 mm, 10 mm



**NIEUW**

**Schroefbitset E-22850**  
31 stuks Impact Black

## ACCU SLAGSCHROEVENDRAAIERS



TD002GZ04

TD003GZ01



**TD002:**  
verlichting met 4 led's



**"Dual spring technology" (TD002G):**

Het slagmechanisme wordt aangedreven door één veer bij licht gebruik en twee veren in zwaar gebruik. Daardoor wordt het slagvermogen beter aangepast aan de belasting. De machine produceert minder trillingen en lawaai bij licht werk en anderzijds is bij het maximum vermogen de slagkracht hoger.



Promo: gratis DEAML006G bij TD001GZ02

	TD003GZ01	TD001GZ02	TD002GZ04
Spanning	36 V (40Vmax)	36 V (40Vmax)	36 V (40Vmax)
Bijgeleverde accu's	-	-	-
Lader	-	-	-
Bitopname	1/4" hex	1/4" hex	1/4" hex
Max. koppel	210 Nm	220 Nm	220 Nm
Slagkrachtniveaus	4	4	4
Hulpfuncties	1	6	6
Gewicht	1,7-2,9 kg	1,7-2,9 kg	1,7-2,9 kg
Prijs in €	excl. btw		
	incl. btw		

# NEXT GENERATION TECHNOLOGY

## ACCU SLAGMOERSLEUTELS



TW004GD201



TW007GD201

TW002GZ



Robuust slagmechanisme

Promo:  
gratis 14-delige  
doppenset  
IMPACT BLACK  
E-16586  
bij TW007GD201



TW001G

### NIEUW

	TW004GZ	TW004GD201	TW007GZ01	TW007GD201	TW002GZ	TW001GZ01
Spanning	36 V (40Vmax)	36 V (40Vmax)	36 V (40Vmax)	36 V (40Vmax)	36 V (40Vmax)	36 V (40Vmax)
Bijgeleverde accu's	0	2 x BL4025	0	2x BL4025	0	0
Bijgeleverde lader	-	DC40RA	-	DC40RA	-	-
Toerental	0-3200 tpm	0-3200 tpm	600-2300 tpm	600-2300 tpm	0-1800 tpm	0-1800 tpm
Max. koppel	350 Nm	350 Nm	760 Nm	760 Nm	1700 Nm	1800 Nm
Dopaansluiting	1/2"	1/2"	1/2"	1/2"	1/2"	3/4"
Verpakking	-	Makpac	Makpac	Makpac	Makpac	Makpac
Gewicht	1,9 - 2,2 kg	1,9 - 2,2 kg	2,7 - 3,3 kg	2,7 - 3,3 kg	3,9 - 5,1 kg	3,9 - 4,2 kg
Prijs in €	excl. btw				Coming soon !	
	incl. btw				Coming soon !	



## ACCU BREEKMOERSLEUTEL



- Voor het vastzetten van breekbouten (type HTB en SHTB)
- Compatibel met boutmaten M16 – M20 – M22
- Accessoires voor M20 en M22 bijgeleverd
- Breekbouten worden vooral gebruikt bij industriële staalconstructies.

		TW001GZ
Spanning		40Vmax
Accu's/lader		-
Toerental onbelast		17 min <sup>-1</sup>
Max. koppel		804 Nm
Compatibiliteit HTB		M16, M20, M22
Compatibiliteit SHTB		M16, M20
Gewicht		5,2 - 5,9 kg
Prijs in €	excl. btw	
	incl. btw	

## 4-snijder hamerboren met lasergelaste hardmetalen boorpunt

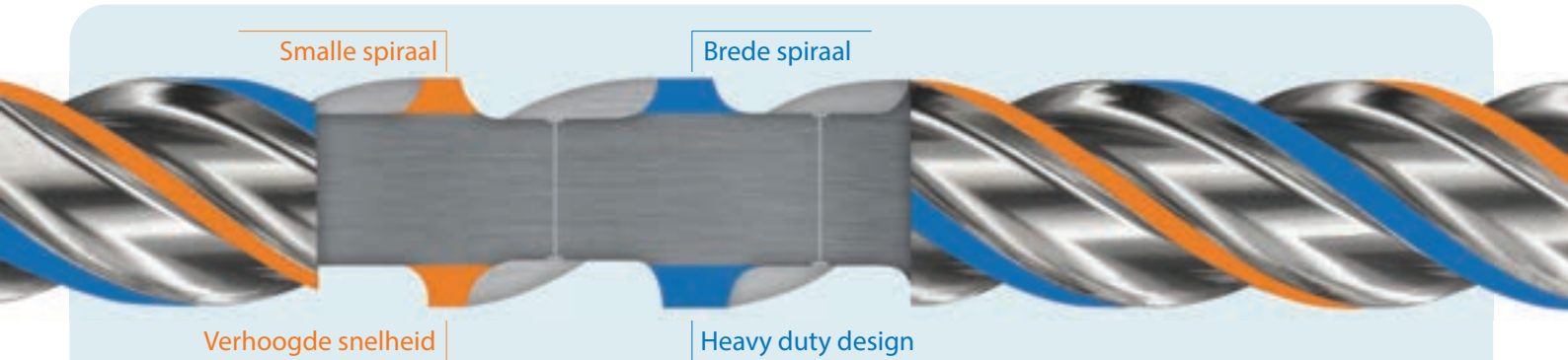

### Hogere Snelheid

- > De smalle spiraal zorgt voor minder wrijving en snellere boorprestaties!
- > Vlottere afvoer van het boorgruis dankzij het lasergelaste boorpunt en de dubbele spiraal.
- > Lasergelaste carbide boorpunten t.e.m. Ø 16 mm.

### Zware klus

- > De brede spiraal zorgt voor een structurele versterking van de kern en minder last van slijtage.
- > Dankzij het robuust ontwerp is de Nemesis II-boor veilig, geschikt voor de zwaarste klus en loopt ze niet vast op betonstaal.

### Langere levensduur

- > Verhoogde weerstand tegen oververhitting dankzij het lasergelaste boorpunt.
- > Het solide uit 1 stuk vervaardigd hardmetalen boorpunt zorgt voor lage vibraties en optimale boorprestaties.

Ø 5 – 10 mm

**4-snijder: Solide hardmetalen boorpunt**



Ø 11 – 16 mm

**4-snijder: Solide uit één stuk vervaardigd hardmetalen boorpunt**



SCAN HIER



Voor volledige assortiment

Ø 18 – 32 mm

**4-snijder: Solide driedelig hardmetalen boorpunt**





## ACCU HAAKSE BOORMACHINE



DA001GM101

- Zeer hoog koppel (136 Nm)
- Twee mechanische snelheden
- Ingebouwde mechanische slipkoppeling

		DA001GZ01	DA001GM101
Spanning		36 V (40Vmax)	36 V (40Vmax)
Bijgeleverde accu's		-	1 x BL4040
Bijgeleverde lader		-	DC40RA
Toerental		0 - 400 t.p.m. 0 - 1500 t.p.m.	0 - 400 t.p.m. 0 - 1500 t.p.m.
Hard koppel		70/136 Nm	70/136 Nm
Boorkop		13 mm	13 mm
Gewicht		5,3 - 6,2 kg	5,3 - 6,2 kg
Prijs in €	excl. btw		
	incl. btw		

## ACCU COMBIHAMERS SDS-PLUS



HR010GZ01



HR007GM201

### HR010G

- Licht, compact en toch krachtig
- Speciale behuizing en handgreep reduceren de trillingen
- Optioneel verkrijgbaar: DX16 stofafzuigingsunit
- De perfecte oplossing voor het boren van kleinere diameters!



HR002GM204



HR009GZ02

	HR010GZ01	HR007GZ01	HR007GM201	HR002GZ02	HR002GM204	HR009GZ02	HR009GM202
Spanning	36 V (40Vmax)	36 V (40Vmax)	36 V (40Vmax)	36 V (40Vmax)	36 V (40Vmax)	36 V (40Vmax)	36 V (40Vmax)
Bijgeleverde accu's	-	-	2 x BL4040	-	2 x BL4040	-	2 x BL4040
Lader	-	-	DC40RA	-	DC40RA	-	DC40RA
Slagenergie	2,0 J	3,0 J	3,0 J	2,9 J	2,9 J	3,9 J	3,9 J
Max. Ø beton	20 mm	28 mm	28 mm	28 mm	28 mm	30 mm	30 mm
AFT	-	✓	✓	✓	✓	✓	✓
Trillingsniveau (ah)	10,0 m/s <sup>2</sup>	7,5 m/s <sup>2</sup>	7,5 m/s <sup>2</sup>	6,0 m/s <sup>2</sup>	6,0 m/s <sup>2</sup>	9,1 m/s <sup>2</sup>	9,1 m/s <sup>2</sup>
Stofafzuigingsunit	DX16: optioneel	DX15: optioneel	DX15: optioneel	DX14: optioneel	DX14: inbegrepen	DX11: inbegrepen	DX11: inbegrepen
AWS	✓ (excl. Bluetooth unit)	✓ (excl. Bluetooth unit)	✓ (excl. Bluetooth unit)	✓	✓	✓ (excl. Bluetooth unit)	✓ (excl. Bluetooth unit)
Gewicht	2,9 - 4,5 kg	3,8 - 4,8 kg	3,8 - 4,8 kg	4,1 - 4,6 kg	4,1 - 4,6 kg	5,3 - 6,7 kg	5,3 - 6,7 kg
Prijs in €	excl. btw						
	incl. btw						

### AFT Active feedback sensing technology

Deze technologie schakelt de motor onmiddellijk uit bij het plots blokkeren van de machine. Sommige machines maken daarbij gebruik van een accelerometer die de zwenkbeweging van de machine detecteert. De AFT-technologie verhoogt de veiligheid enorm.



Slagenergie  
**8,0 J**



HR005GM202



HR006GZ

Slagenergie  
**20,0 J**

### HR005G

- Uitstekende vermogen/gewichtsverhouding
- Beveiliging tegen terugslag (AFT met accelerometer)
- Actieve trillingsdemping (AVT)

### HR006G

- 2 x 40Vmax accu's in serie zorgen voor extreme kracht
- Beveiliging tegen terugslag (AFT met accelerometer)
- Actieve trillingsdemping (AVT)

	HR005GZ01	HR005GM202	HR006GZ
Spanning	36 V (40 Vmax)	36 V (40 Vmax)	2 x 36 V (40 Vmax)
Bijgeleverde Accu's	-	2 x BL4040	-
Slagenergie	8,0 J	8,0 J	20,0 J
Slagfrequentie	1450 - 2900 min <sup>-1</sup>	1450 - 2900 min <sup>-1</sup>	1100 - 2250 min <sup>-1</sup>
Trillingsniveau (ah)	5 m/s <sup>2</sup>	5 m/s <sup>2</sup>	8,5 m/s <sup>2</sup>
Capaciteit beton	40 mm	40 mm	52 mm
Toerental onbelast	250 - 500 min <sup>-1</sup>	250 - 500 min <sup>-1</sup>	250 - 310 min <sup>-1</sup>
AFT	✓	✓	✓
AWS	✓	✓	✓ (excl. Bluetooth unit)
Gewicht	7,4 kg - 8,2 kg	7,4 kg - 8,2 kg	12,9 - 14,3 kg
Prijs in €	excl. btw		
	incl. btw		

## PREMIUM BEITELSET SDS-PLUS EN SDS-MAX

- ✓ 2 keer langere levensduur dan de standaard beitels!
- ✓ Zeer efficiënt: vormvast. Het afbraakwerk is veel productiever!

### 3-DELIGE PREMIUM BEITELSET SDS-PLUS

### 5-DELIGE PREMIUM BEITELSET SDS-MAX

#### SDS-PLUS

E-20220

excl. btw

incl. btw



- 1 puntbeitel 250 mm
- 1 koudbeitel 20 x 250 mm
- 1 platte beitel 40 x 250 mm



#### AntiJam™ ontwerp

Verhoogt de productiviteit  
Vermindert de wrijving en de kans op blokkeren  
Speciaal ontworpen voor SDS-PLUS machines



#### SDS-MAX

E-20236

excl. btw

incl. btw



- 2 puntbeitels 400 mm
- 2 koudbeitels 25 x 400 mm
- 1 platte beitel 50 x 380 mm



#### BreakPower™ ontwerp

Verhoogt de productiviteit  
Vermindert de wrijving en de kans op blokkeren  
Speciaal ontworpen voor SDS-MAX machines

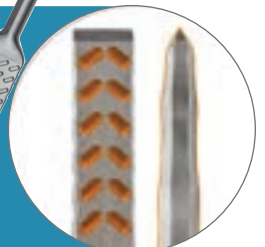

ACCU BREEKHAMERS SDS-MAX

**BL**  
MOTOR

**XGT**  
**40V<sup>max</sup>** Li-ion

**XGT X2**  
**80V<sup>max</sup>**

## HM001G



- Evenaart de kracht van modellen op netstroom
- Hoge slagenergie (9,4 J)
- Uitzonderlijk laag trillingsniveau dankzij actieve trillingsdemping (AVT) en een anti-vibratie behuizing



HM001GM205

Slagenergie  
**9,4 J**

## HM002G



- Extreem krachtig dankzij twee 40Vmax accu's in serie
- Zeer hoge slagenergie (20 J)
- Uitzonderlijk laag trillingsniveau dankzij actieve trillingsdemping (AVT) en een anti-vibratie behuizing



HM002GZ03

Slagenergie  
**20,0 J**

	HM001GZ04	HM001GM205	HM002GZ03
Spanning	36 V (40Vmax)	36 V (40Vmax)	2 x 36 V (40Vmax)
Bijgeleverde accu's	-	2 x BL4040	-
Bijgeleverde lader	-	DC40RA	-
Slagenergie	9,4 J	9,4 J	20 J
Slagfrequentie	0 - 2650 min <sup>-1</sup>	0 - 2650 min <sup>-1</sup>	950 - 1900 min <sup>-1</sup>
Triax. vibratie beitelten (ah)	6,0 m/s <sup>2</sup>	6,0 m/s <sup>2</sup>	8,0 m/s <sup>2</sup>
AWS	✓	✓	✓ excl. Bluetooth unit
Gewicht	6,3 - 7,1 kg	6,3 - 7,1 kg	12,0 - 13,3 kg
Prijs in €	excl. btw		
	incl. btw		





ACCUBREEKHAMER SDS-MAX

**BL**  
MOTOR

**XGT**  
**40V** Li-ION  
max

## HM004G

- Zeer krachtige accubreekhamer met impactenergie van 72,8 J, vergelijkbaar met modellen op netstroom
- Grote energiecapaciteit (autonomie) bij gebruik van twee 8,0 Ah 40Vmax accu's
- Uitstekende trillingsdemping (AVT)
- Uitstekend zicht op de beitel

Actieve trillingsdemping met bewegend tegengewicht (AVT)



Tegengewicht

Piston



HM004GZ01

**NIEUW**

**HM004GZ01**

Spanning	72 V (80Vmax)
Bijgeleverde accu's	-
Opname	28,6 mm
Slagenergie	72,8 J
Slagfrequentie	870 min <sup>-1</sup>
Trillingsniveau	6,5 m/s <sup>2</sup>
Gewicht	29,7 - 32,1 kg
Prijs in €	excl. btw
	incl. btw

Om de dikte van de machine te beperken zijn de accu's zijdelings geplaatst. Daardoor is de werkhouding comfortabel en het zicht op de beitel uitstekend.



De behuizing is via trillingsdempende veren met het binnenste deel verbonden om nog minder trillingen op de armen door te geven



# NEXT GENERATION TECHNOLOGY

## ACCU METAALCIRKELZAAG 185 MM



CS002GZ

- Grote snijcapaciteit dankzij de compacte tandwieloverbrenging
- Compartiment in aluminium voor het opvangen van metaalsnippers
- De AFT functie schakelt de motor onmiddellijk uit wanneer het zaagblad blokkeert

		CS002GZ
Spanning		36 V (40Vmax)
Bijgeleverde accu's/lader		-
Ø zaagblad		185 mm
Toerental onbelast		3500 min <sup>-1</sup>
Max. zaagdiepte		67 mm
Trillingsniveau (ah)		2,5 m/s <sup>2</sup>
Gewicht		4,2 - 5,4 kg
Prijs in €	excl. btw	
	incl. btw	

## ACCU MENGERS



- Zeer krachtig, ook geschikt voor het mengen van zwaardere materialen
- Mechanische overbrenging met 2 snelheden
- Duimwiel voor het instellen van het maximaal toerental, variabel toerental regeling, aan-vergrendelknop en uit-vergrendelknop, softstart
- Inschroefbare ashouder met adapter M12 + M14 binnendraad
- Uitstekende bescherming van schakelaar en accu



**Optioneel accessoire:**  
beschermkap "L" voor BL4050F en BL4080F (1911R6-2)

		UT001GZ02
Spanning		36V (40Vmax)
Bijgeleverde accu's		-
Bijgeleverde lader		-
Toerental onbelast		0- 500min <sup>-1</sup> 0- 920min <sup>-1</sup>
Aansluiting		1/2" - 20 UNF Male Adapter M12 & M14
Gewicht		5,7-7,0 kg
Prijs in €	excl. btw	
	incl. btw	

## ACCU BETONTRILNAALDEN



VR001GZ



VR004GM101



## ACCESSOIRES

Artikel	Diameter	Lengte	Prijs excl. btw	Prijs incl. btw
1910E1-5	32 mm	1,2 m		
1910E2-3	32 mm	1,7 m		
1910C2-9	32 mm	2,4 m		
1910E3-1	38 mm	1,2 m		
1910C4-5	38 mm	2,4 m		



	VR001GZ	VR003GZ	VR004GZ	VR004GM101
Spanning	36 v (40Vmax)	36 v (40Vmax)	36 v (40Vmax)	36 v (40Vmax)
Bijgeleverde accu's	-	-	-	1x BL4040
Bijgeleverde lader	-	-	-	DC40RA
Ø triffles	-(enkel motor)	32 mm	38 mm	38 mm
Lengte naald	-(enkel motor)	1,2 m	1,2 m	1,2 m
Trillingsfrequentie	12000-15000 min <sup>-1</sup>	12000-15000 min <sup>-1</sup>	12000-15000 min <sup>-1</sup>	12000-15000 min <sup>-1</sup>
Gewicht	4,8 - 7,8 kg	4,8 - 7,8 kg	4,8 - 7,8 kg	4,8 - 7,8 kg
Prijs in €	excl. btw			
	incl. btw			



## ACCU HAAKSE SLIJERS 125 MM X-LOCK

**BL**  
MOTOR

**AWS**  
Auto-start Wireless System

**XGT**  
**40Vmax**  
Lithium



191G05-4  
STOFAFZUIGKAP X-LOCK

**X-LOCK**

Snel en veilig schijven bevestigen via een kliksysteem.

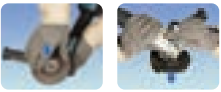

GA044GM201

	GA041GZ	GA041GM201	GA044GZ	GA044GM201	GA047GZ	GA047GM201
Spanning	36 V (40Vmax)	36 V (40Vmax)	36 V (40Vmax)	36 V (40Vmax)	36 V (40Vmax)	36 V (40Vmax)
Bijgeleverde accu's	-	2x BL4040	-	2x BL4040	-	2x BL4040
Bijgeleverde lader	-	DC40RA	-	DC40RA	-	DC40RA
Schijfdiameter	125 mm	125 mm	125 mm	125 mm	125 mm	125 mm
Toerental onbelast	3,000 - 8,500 min <sup>-1</sup>	3,000 - 8,500 min <sup>-1</sup>	3,000 - 8,500 min <sup>-1</sup>	3,000 - 8,500 min <sup>-1</sup>	8,500 min <sup>-1</sup>	8,500 min <sup>-1</sup>
Slijpdiepte	31 mm	31 mm	31 mm	31 mm	31 mm	31 mm
Type schakelaar	Schuifschakelaar	Schuifschakelaar	Lepelschakelaar	Lepelschakelaar	Lepelschakelaar	Lepelschakelaar
Dodemannsschakelaar	-	-	✓	✓	✓	✓
AWS	✓	✓	✓	✓	-	-
Verpakking	-	Makpac	-	Makpac	-	Makpac
Gewicht	3.0 - 5.3 kg	3.0 - 5.3 kg	3.0 - 5.3 kg	3.0 - 5.3 kg	3.0 - 5.3 kg	3.0 - 5.3 kg
Prijs in €	excl. btw					
	incl. btw					

## XGT COMBOKIT



**NIUW**

**DK0227G201**

Spanning	36 V (40Vmax)
Bijgeleverde accu's	2x BL4040F
Bijgeleverde lader	DC40RA
Opname slijpers	M14
Haakse slijper 125mm	GA023G
Haakse slijper 230 mm	GA038G
Verpakking	Gereedschapstas
Prijs in €	excl. btw
	incl. btw

## ACCESSOIRES X-LOCK

Referentie	Type	Prijs excl. btw	Prijs incl. btw
E-00393	Afbraamschijf voor metaal 125 mm x 6 x 22,23		
E-00402	Afbraamschijf voor inox 125 mm x 6 x 22,23		
E-00418	Doorslijpschijf voor inox 125 mm x 1,2 x 22,23		
E-02076	Diamantdoorslijpschijf 125 mm		
D-73396	Komborstel voor metaal, gegolfde draad 75 mm x 0,3		
D-73433	Komborstel voor metaal, gegolfde draad, vermessingd 75 mm x 0,3		
D-73346	Komborstel voor inox, gegolfde draad 75 mm x 0,3		

Referentie	Type	Prijs excl. btw	Prijs incl. btw
D-73374	Komborstel voor metaal, getordeerde draad 80 mm x 0,35		
D-73380	Komborstel voor metaal, getordeerde draad 80 mm x 0,5		
D-73330	Komborstel voor inox, getordeerde draad 80 mm x 0,5		
D-73449	Kegelborstel voor metaal, gegolfde draad 100 mm x 0,3		
D-73411	Schijfborstel voor metaal, getordeerde draad 115 mm x 0,5		
D-73427	Schijfborstel voor metaal, gegolfde draad 115 mm x 0,3		
E-11776	Doorslijpschijf TCG 125 mm x 2 x 22,23 X-Lock		
E-19738	Vacuüm gesoldeerde diamantschijf 125 mm		



# NEXT GENERATION TECHNOLOGY

## ACCU HAAKSE SLIJPERS 125 MM



### GA050G

- Compact, zeer hoog vermogen en hoog toerental
- Speciale motorbehuizing in één stuk en trillings-absorberende rubbers tussen de binnen- en buitenkant
- Vernieuwd ontwerp met kleine greepomtrek

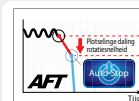

**Active Feedback sensing Technology**  
Schakelt de motor uit bij het plots blokkeren van de schijf

#### STOFAFZUIGING VOOR SLIJPERS



191F81-2



191G06-2

#### Gereedschaploze beschermkap

- Er is geen gereedschap nodig om de kap te monteren of te verwijderen.
- De beschermkap kan via een kliksysteem in de gewenste stand geplaatst worden.

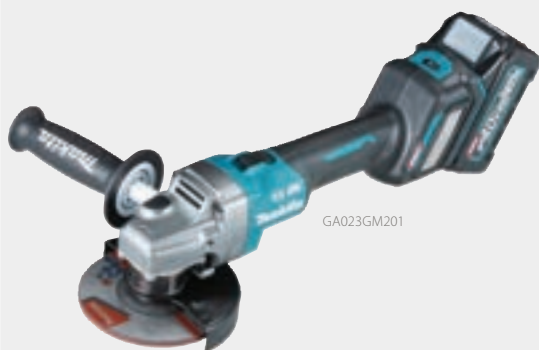

GA023GM201



GA050GZ

	GA005GZ01	GA005GM201	GA013GZ01	GA013GM201	GA050GZ	GA023GZ	GA023GM201	GA029GZ	GA029GM201
Spanning	36 V (40Vmax)	36 V (40Vmax)	36 V (40Vmax)	36 V (40Vmax)	36 V (40Vmax)	36 V (40Vmax)	36 V (40Vmax)	36 V (40Vmax)	36 V (40Vmax)
Bijgeleverde accu's	0	2 x BL4040	0	2 x BL4040	-	0	2 x BL4040	0	2 x BL4040
Bijgeleverde lader	-	DC40RA	-	DC40RA	-	-	DC40RA	-	DC40RA
Toerental onbelast	8500 t.p.m.	8500 t.p.m.	8500 t.p.m.	8500 t.p.m.	11000 t.p.m.	3000 - 8500 t.p.m.	3000 - 8500 t.p.m.	3000 - 8500 t.p.m.	3000 - 8500 t.p.m.
Regelbaar toerental	-	-	-	-	-	✓	✓	✓	✓
Type schakelaar	Schuifschakelaar met vergrendeling	Schuifschakelaar met vergrendeling	Lepelschakelaar zonder vergrendeling	Lepelschakelaar zonder vergrendeling	Lepelschakelaar zonder vergrendeling	Schuifschakelaar met vergrendeling	Schuifschakelaar met vergrendeling	Lepelschakelaar zonder vergrendeling	Lepelschakelaar zonder vergrendeling
AWS	-	-	-	-	-	✓	✓	✓	✓
Verpakking	Makpac	Makpac	Makpac	Makpac	-	-	Makpac	-	Makpac
Gewicht	3,0 kg	3,0 kg	3,0 kg	3,0 kg	3,0 kg	3,0 kg	3,0 kg	3,0 kg	3,0 kg
Prijs in €	excl. btw								
	incl. btw								

## ACCU HAAKSE SLIJPERS 150 MM / 180 MM / 230 MM



Compacte afmetingen en kleine omtrek van de handgreep



GA038GM201



	GA035GZ	GA036GZ	GA037GZ01	GA037GM201	GA037GT201	GA038GZ01	GA038GM201	GA038GT201
Spanning	36 V (40Vmax)	36 V (40Vmax)	36 V (40Vmax)	36 V (40Vmax)	36 V (40Vmax)	36 V (40Vmax)	36 V (40Vmax)	36 V (40Vmax)
Bijgeleverde accu's	-	-	-	2 x BL4040	2 x BL4050F	-	2 x BL4040	2 x BL4050F
Bijgeleverde lader	-	-	-	DC40RA	DC40RA	-	DC40RA	DC40RA
Schijfdiameter	150 mm	150 mm	180 mm	180 mm	180 mm	230 mm	230 mm	230 mm
Toerental onbelast	8500 min <sup>-1</sup>	8500 min <sup>-1</sup>	7800 min <sup>-1</sup>	7800 min <sup>-1</sup>	7800 min <sup>-1</sup>	6600 min <sup>-1</sup>	6600 min <sup>-1</sup>	6600 min <sup>-1</sup>
Slijpdiepte	46 mm	46 mm	68 mm	68 mm	68 mm	73 mm	73 mm	73 mm
Type schakelaar	Schuifschakelaar met vergrendeling	Lepelschakelaar zonder vergrendeling	Lepelschakelaar zonder vergrendeling	Lepelschakelaar zonder vergrendeling	Lepelschakelaar zonder vergrendeling	Lepelschakelaar zonder vergrendeling	Lepelschakelaar zonder vergrendeling	Lepelschakelaar zonder vergrendeling
AWS	-	-	excl. Bluetooth unit	excl. Bluetooth unit	excl. Bluetooth unit	excl. Bluetooth unit	excl. Bluetooth unit	excl. Bluetooth unit
Verpakking	-	-	Koffer	Koffer	Koffer	Koffer	Koffer	Koffer
Gewicht	3,0 - 3,7 kg	3,0 - 3,7 kg	4,4 - 5,4 kg	4,4 - 5,4 kg	4,4 - 5,4 kg	4,6 - 7,4 kg	4,6 - 7,4 kg	4,6 - 7,4 kg
Prijs in €	excl. btw							
	incl. btw							

## CE001G

- Uiterst krachtig dankzij 2x 40Vmax technologie
- Met soft start, AFT en elektrische rem
- Geïntegreerde watertoevoer
- XPT en Wetguard (IPX4) bescherming
- De combinatie van AVT technologie en een trillingsabsorberende behuizing zorgen voor een zeer laag vibratieniveau.

Promo: gratis  
diamantschijf  
355 mm E-12996  
bij CE001GZ



CE001GZ



CE002GZ01

## CE002G

- Versie zonder wateraansluiting, ontworpen voor droog zagen
- Met AWS & stofzuigaansluiting
- Incl. diamantschijf



	CE001GZ	CE002GZ01
Spanning	72 V (80Vmax)	72 V (80Vmax)
Bijgeleverde accu's/lader	-	-
Ø zaagblad	355 mm	355 mm
Toerental onbelast	5300 min <sup>-1</sup>	4200 min <sup>-1</sup>
Max. zaagdiepte	127 mm	127 mm
Trillingsniveau (ah) vooraan / achteraan	2,5 m/s <sup>2</sup> / 1,8 m/s <sup>2</sup>	2,5 m/s <sup>2</sup> / 1,8 m/s <sup>2</sup>
AWS	-	✓
Gewicht	12,3 - 14,1 kg	13,1 - 15,1 kg
Prijs in €	excl. btw	
	incl. btw	

## DIAMANTSCHIJVEN

	Artikel	Ø	Dikte	Hoogte segment	Ø asgat	Reductiering	Prijs excl. btw	Prijs incl. btw
<b>Quasar</b>	B-12712	230 mm	2,6 mm	12 mm	22,23 mm	20 mm		
	B-17588	300 mm	3,0 mm	12 mm	25,4 mm	20 mm		
	B-13465	350 mm	3,0 mm	12 mm	25,4 mm	20 mm		
	B-13471	400 mm	3,0 mm	12 mm	25,4 mm	20 mm		
<b>Comet</b>	B-12784	230 mm	2,6 mm	12 mm	22,23 mm	20 mm		
	B-17619	300 mm	3,0 mm	10 mm	25,4 mm	20 mm		
	B-13552	350 mm	3,0 mm	10 mm	25,4 mm	20 mm		
	B-13568	400 mm	3,0 mm	10 mm	25,4 mm	20 mm		
<b>Asfalt</b>	B-13275	350 mm	3,2 mm	10 mm	25,4 mm	20 mm		
	B-42905	400 mm	3,2 mm	10 mm	25,4 mm	20 mm		

	Artikel	Ø extern	Ø intern	Dikte	Prijs excl. btw	Prijs incl. btw
<b>Reductieringen</b>	257199-4	22,23 mm	20,00 mm	3,0 mm		
	197318-9	25,4 mm	20,00 mm	5 mm		

## ACCU DOORSLIJPER 230MM



CE003GZ02

- Schijfdiameter 230 mm
- Zeer goede vermogen/gewichtsverhouding
- Voor het doorslijpen van metaal met abrasieve schijf of nat doorslijpen in steen of beton met diamantschijf.
- Met aansluiting voor waterslang
- Door het relatief lage gewicht en compacte bouw ideaal voor het slijpen in moeilijke situaties, bijvoorbeeld laag bij de grond of verticaal.
- Incl. doorslijpschijf voor metaal

NIEUW

CE003GZ02

Spanning	40Vmax
Bijgeleverde accu's/lader	-
Ø zaagblad	230 mm
Toerental onbelast	6600 min <sup>-1</sup>
Max. zaagdiepte	88 mm
Trillingsniveau links/rechts	3,0 / 1,9 m/s <sup>2</sup>
Gewicht	6,4 – 7,4 kg
Prijs in €	excl. btw
	incl. btw

## ACCU DOORSLIJPER 305MM



NIEUW

CE004GZ

Spanning	40Vmax
Bijgeleverde accu's/lader	-
Ø zaagblad	305 mm
Toerental onbelast	5000 min <sup>-1</sup>
Max. zaagdiepte	121 mm
Trillingsniveau (ah)	3,8 / 2,3 m/s <sup>2</sup>
Gewicht	6,7 – 7,7 kg
Prijs in €	excl. btw
	incl. btw

- Schijfdiameter 305 mm
- Zeer goede vermogen/gewichtsverhouding
- Voor het doorslijpen van metaal met abrasieve schijf of nat doorslijpen in steen of beton met diamantschijf.
- Met aansluiting voor waterslang



CE004GZ



## ACCU RECIPROZAGEN



JR002GM201



**JR002G**

- Vermogen vergelijkbaar met model op netstroom
- Met pendelmechanisme (JR002G)
- Zeer laag trillingsniveau dankzij AVT technologie
- Handige bladontgrendelingshendel en verstelbare aanslag
- Ledverlichting



JR001GD201



### Gedempte ophanging

De accu en de behuizing zijn verbonden met trillingsabsorberende rubbers.

### Gereedschapsloze aanpassing van de aanslag



	JR001GZ	JR001GD201	JR001GM201	JR002GZ	JR002GM201
Spanning	36 V (40Vmax)	36 V (40Vmax)	36 V (40Vmax)	36 V (40Vmax)	36 V (40Vmax)
Bijgeleverde accu's	0	2 x BL4025	2 x BL4040	-	2 x BL4040
Bijgeleverde lader	-	DC40RA	DC40RA	-	DC40RA
Slaglengthe	32 mm	32 mm	32 mm	32 mm	32 mm
Aantal zaagbewegingen	0 - 2300 min <sup>-1</sup> 0 - 3000 min <sup>-1</sup>	0 - 2300 min <sup>-1</sup> 0 - 3000 min <sup>-1</sup>	0 - 2300 min <sup>-1</sup> 0 - 3000 min <sup>-1</sup>	0 - 3000 min <sup>-1</sup> 0 - 3000 min <sup>-1</sup>	0 - 3000 min <sup>-1</sup> 0 - 3000 min <sup>-1</sup>
Pendelinstelling	-	-	-	✓	✓
AVT	-	-	-	✓	✓
Gewicht	4,2 - 4,5 kg	4,2 - 4,5 kg	4,2 - 4,5 kg	4,6 - 5,8 kg	4,6 - 5,8 kg
Prijs in €	excl. btw				
	incl. btw				

## ACCU BANDZAGEN



PB002GM201

- Grote zaagcapaciteit tot Ø127 mm
- Variabele snelheidsregeling
- Hoge bandsnelheid
- Gemakkelijke spoorverstelling

	PB002GZ	PB002GM201
Spanning	36 V (40Vmax)	36 V (40Vmax)
Bijgeleverde accu's	-	2x BL4040
Bijgeleverde lader	-	DC40RA
Zaagcapaciteit	127 x 127 mm	127 x 127 mm
Zaaglint	1140 x 13 x 0,5 mm	1140 x 13 x 0,5 mm
Gewicht	6,6 - 7,8 kg	6,6 - 7,8 kg
Prijs in €	excl. btw	
	incl. btw	

## ACCU POLIJSTMACHINE



PV001GM101



	PV001GZ	PV001GM101
Spanning	36 V (40Vmax)	36 V (40Vmax)
Bijgeleverde accu's	-	1x BL4040
Bijgeleverde lader	-	DC40RA
Diameter	180 mm	180 mm
Toerental onbelast	0 - 2200 min <sup>-1</sup>	0 - 2200 min <sup>-1</sup>
Gewicht	3,2 - 3,9 kg	3,2 - 3,9 kg
Prijs in €	excl. btw	
	incl. btw	

ACCU MULTITOOL



TM001GZ

## TM001GZ02-TM001GZ03

- Compatibel met STARLOCK, STARLOCK PLUS en STARLOCK Max accessoires
- Grote oscillatiehoek van 3,6°
- Uiterst lage trillingswaarden dankzij AVT technologie
- Variabele snelheidsregeling
- Versie TM001GZ03: inclusief 32 accessoires

	NIEUW TM001GZ02	NIEUW TM001GZ03
Spanning	36 V (40Vmax)	36 V (40Vmax)
Bijgeleverde accu's	-	-
BL motor	✓	✓
Oscillatiefrequentie	10000-20000 /min	10000-20000 /min
Oscillatiehoek	3,6°	3,6°
Opname	Starlock, Starlock Plus, Starlock Max	Starlock, Starlock Plus, Starlock Max
Gewicht	2,0 kg	2,0 kg
Prijs in €	excl. btw	
	incl. btw	

### STARLOCK



### STARLOCK PLUS



### STARLOCK MAX



Voor het volledig overzicht van het assortiment scan hier

- ✓ Snelle wissel van accessoires door een simpele klik
- ✓ Starlock Plus zaagbladen : snel, diep en veelzijdig invallend zagen
- ✓ Starlock Max zaagbladen : zelfs voor de meest veeleisende en zware toepassingen

Starlock Plus en Starlock Max accessoires kunnen enkel gebruikt worden met de DTM52.

ACCU SCHAAF



- Even krachtig als een machine op netstroom
- Kan tot 4,0 mm in één passage schaven
- Spaanders kunnen links of rechts uitgeworpen worden
- Zool met 3 groeven voor het afschuiven van kanten
- Sponningsdiepte tot 25 mm

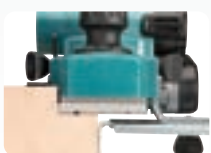

KP001GM202

	KP001GZ01	KP001GM202
Spanning	36 V (40Vmax)	36 V (40Vmax)
Bijgeleverde accu's	-	2x BL4040
Bijgeleverde lader	-	DC40RA
Toerental onbelast	15000 min <sup>-1</sup>	15000 min <sup>-1</sup>
Schaafbreedte	82 mm	82 mm
Max. spaanafname	40mm	40mm
AWS	✓	✓
Gewicht	3,7 - 4,9 kg	3,7 - 4,9 kg
Prijs in €	excl. btw	
	incl. btw	

## ACCU INVALCIRKELZAAG

MAK  
PAC

BL  
MOTOR

XGT  
40V<sup>Li-ion</sup>  
max



SP001GZ03



**AWS compatibel**  
Voor het draadloos aansturen van een AWS compatibele stofzuiger.  
(incl. Bluetooth unit)

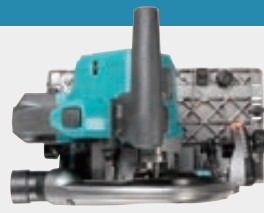

**Compact en licht, perfect uitgebalanceerd.**  
Door het gebruik van slechts één 40Vmax accu en magnesium componenten.



**Perfekte geleiding**  
De magnesium zool past rechtstreeks op een geleiderail.



**Grote zaagcapaciteit**  
Zaagdiepte van 56 mm bij 90° en een kantelbereik van -1 tot 48°.

### SP001GZ03

Spanning	36 V (40Vmax)	
Bijgeleverde accu's	-	
Ø zaagblad	165 mm	
Toerental onbelast	2500 - 4900 min <sup>-1</sup>	
Zaagdiepte (90°)	56 mm	
AWS	✓	
Gewicht	4,4 - 5,0 kg	
Prijs in €	excl. btw	
	incl. btw	

## ACCU DECOUPEERZAGEN

BL  
MOTOR

XGT  
40V<sup>Li-ion</sup>  
max

### JV001G/ JV002G

- 3 pendelinstellingen + recht snijden
- Brede basisplaat voor uitstekende stabiliteit
- De soft-no-load functie verlaagt het toerental bij lage belasting
- JV002G: model met beugelgreep



JV002GZ



JV001GZ01

## OPTIONEEL ACCESSOIRE

Voor een snelle en perfecte afwerking bij het zagen van dikker plaatmateriaal en bij golvende lijnen

	JV001GZ01	JV001GM201	JV002GZ
Spanning	36 V (40Vmax)	36 V (40Vmax)	36 V (40Vmax)
Bijgeleverde accu's	-	2x BL4040	-
Bijgeleverde lader	-	DC40RA	-
Aantal zaagbewegingen	800 - 3500 min <sup>-1</sup>	800 - 3500 min <sup>-1</sup>	800 - 3500 min <sup>-1</sup>
Max. capaciteit hout	135 mm	135 mm	135 mm
Slaglengte	26 mm	26 mm	26 mm
Gewicht	2,6 - 2,9 kg	2,6 - 2,9 kg	2,7 - 3,0 kg
Verpakking	Makpac	Makpac	Doos
Prijs in €	excl. btw		
	incl. btw		

NIEUW

Referentie	Totale lengte	Werk-lengte	TPI	Blad-dikte	Toepassing	Prijs excl. btw	Prijs incl. btw	stuks/verpakking
E-22218	105mm	80mm	9	1.5 mm	Hout / Kunststof			5

## XGT COMBOKIT

MAK  
PAC

BL  
MOTOR

XGT  
40V<sup>Li-ion</sup>  
max



SP001G

JV001G

BL4040

DC40RA

199141-8

NIEUW

### DK0228G201

Spanning	36 V (40Vmax)	
Bijgeleverde accu's	2x BL4040	
Bijgeleverde lader	DC40RA	
Invalcirkelzaag 165 mm	SP001G	
Decoupeerzaag	JV001G	
Verpakking	Makpac	
Prijs in €	excl. btw	
	incl. btw	



# NEXT GENERATION TECHNOLOGY



## ACCU CIRKELZAGEN



### HS012G

- Bijzonder krachtige accucirkelzaag met links geplaatst zaagblad.
- Compact, licht en perfect uitgebalanceerd dankzij de nieuw ontwikkelde BL motor.
- Diepteregeling met duidelijk afleesbare schaal en kantelbaar tot 45°.
- De zool en beschermkap zijn uitgevoerd in hoogwaardig magnesium.
- Opgelet deze machine past niet rechtstreeks op een geleiderail.



HS009GT201



HS012GZ01



HS003GM201



HS011GT201

	HS012GZ01	HS003GZ	HS003GM201	HS004GZ	HS004GZ01	HS004GM202	HS009GZ	HS009GT201	HS010GZ	HS010GT201	HS011GZ	HS011GT201
Spanning	36 V (40Vmax)	36 V (40Vmax)	36 V (40Vmax)	36 V (40Vmax)	36 V (40Vmax)	36 V (40Vmax)	36 V (40Vmax)	36 V (40Vmax)	36 V (40Vmax)	36 V (40Vmax)	36 V (40Vmax)	36 V (40Vmax)
Bijgeleverde accu's	-	-	2 x BL4040	-	-	2 x BL4040	-	2x BL4050F	-	2x BL4050F	-	2x BL4050F
Bijgeleverde lader	-	-	DC40RA	-	-	DC40RA	-	DC40RA	-	DC40RA	-	DC40RA
Ø zaagblad	165 mm	190 mm	190 mm	190 mm	190 mm	190 mm	235 mm	235 mm	235 mm	235 mm	270 mm	270 mm
Zaagdiepte (90°)	57 mm	68,5 mm	68,5 mm	62,5 mm	62,5 mm	62,5 mm	85 mm	85 mm	85 mm	85 mm	101 mm	101 mm
Rechtstreeks op geleiderail	-	-	-	✓	✓	✓	✓	✓	-	-	✓	✓
AWS	✓	✓	✓	✓	✓	✓	✓	✓	✓	✓	✓	✓
	excl. Bluetooth unit	excl. Bluetooth unit	excl. Bluetooth unit	excl. Bluetooth unit			excl. Bluetooth unit	excl. Bluetooth unit	excl. Bluetooth unit	excl. Bluetooth unit	excl. Bluetooth unit	excl. Bluetooth unit
Verpakking	Makpac	-	Makpac	-	-	Makpac	-	Koffer	-	Koffer	-	-
Gewicht	3,2 - 4,4kg	4,1 - 4,4 kg	4,1 - 4,4 kg	4,4 - 4,7 kg	4,4 - 4,7 kg	4,4 - 4,7 kg	5,1 - 5,7 kg	5,1 - 5,7 kg	6,0 - 6,4 kg	6,0 - 6,4 kg	5,5 - 6,7 kg	5,5 - 6,7 kg
Prijs in €												
	excl. btw											
	incl. btw											

## ACCU CIRKELZAGEN MET ACHTERHANDGREEP



RS001GM101

### RS001G / RS002G

- Speciaal ontwerp met handgreep achteraan
- Krachtig en licht (magnesium zool)



	RS001GZ	RS001GM101	RS002GZ
Spanning	36 V (40Vmax)	36 V (40Vmax)	36 V (40Vmax)
Bijgeleverde accu's	0	1 x BL4040	0
Zaagdiepte (90°)	65 mm	65 mm	95 mm
Ø zaagblad	185 mm	185 mm	260 mm
AWS	-	-	✓ excl. Bluetooth unit
Toerental onbelast	6400 min <sup>-1</sup>	6400 min <sup>-1</sup>	4000 min <sup>-1</sup>
Gewicht	5,0 - 5,6 kg	5,0 - 5,6 kg	5,7 - 6,3 kg
Prijs in €	excl. btw		
	incl. btw		

## ACCU TELESCOPISCHE AFKORT - VERSTEKZAGEN



Belangrijke bedieningsknoppen zijn vooraan geplaatst



LS002GZ01

Promo:  
gratis onderstel DEBWST06  
t.w.v.

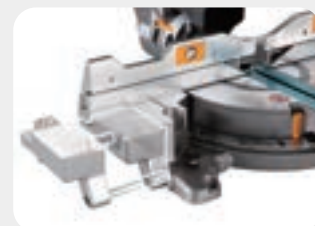

Uitschuifbare zijsteunen



### Efficiënte stofafzuiging

De geoptimaliseerde stofafzuiging met twee poorten garandeert een perfecte stofafzuiging, ook bij het zagen van dunne planken.

Kantelhoek 48°  
links en rechts



### Aanduiding van de zaaglijn

Een led lamp werpt de schaduw van het zaagblad op het werkstuk, deze aanduiding is onder alle omstandigheden exact.



LS003GZ01

# DXT

Deep and Exact Cutting Technology

De gepatenteerde constructie met driedimensionale tandwieloverbrenging en uitsparing achter de flens laat toe om een groter deel van het zaagblad te benutten. Daardoor kunnen ook hoge plinten verticaal of in verstek afgekort worden.



### Manuele bediening

De afzuiging kan via een schakelaar ook manueel gestart worden (via Bluetooth), dit is ook handig om de machine schoon te maken.

	LS002GZ01	LS004GZ01	LS003GZ01
Spanning	36 V (40Vmax)	36 V (40Vmax)	36 V (40Vmax)
Bijgeleverde accu's	0	0	0
Ø zaagblad	216 mm	260 mm	305 mm
Verstekhoek	60 L / 60 R	60° L / 60° R	60 L / 60 R
Kantelhoek	48° L / 48° R	48° L / 48° R	48° L / 48° R
Toerental onbelast	4800 min <sup>-1</sup>	3600 min <sup>-1</sup>	3600 min <sup>-1</sup>
Capaciteit	70 x 312 mm	91 x 312 mm	107 x 312 mm
AWS	✓	✓	✓
DXT	✓	✓	✓
Gewicht	16,4 - 17,0 kg	26,6 - 27,2 kg	30,5 - 31,1 kg
Prijs in €	excl. btw		
	incl. btw		

# NEXT GENERATION TECHNOLOGY

## ACCU BOVEN- EN KANTENFREES



- Compact en flexibel systeem
- Zeer hoog vermogen dankzij 40Vmax technologie
- Zachte rem
- Verschillende hulpstukken meegeleverd

RT001GM208

		RT001GZ16	RT001GM208
Spanning		36 V (40Vmax)	36 V (40Vmax)
Bijgeleverde accu's		-	2x BL4040
Bijgeleverde lader		-	DC40RA
Toerental onbelast		10000-31000 min <sup>-1</sup>	10000-31000 min <sup>-1</sup>
Max. induikdiepte		40 mm	40 mm
Ø spantang - bereik		6 - 8 mm	6 - 8 mm
Ø spantang - inbegrepen		6 mm, 8 mm	6 mm, 8 mm
AWS		✓	✓
		excl Bluetooth unit	excl Bluetooth unit
Gewicht		2,2 - 2,5 kg	2,2 - 2,5 kg
Prijs in €	excl. btw		
	incl. btw		

## ACCU BOVENFREES



### RP001G

- Even krachtig dan een gesnoerd model dankzij 40Vmax technologie
- Licht en compact; gemakkelijk te hanteren
- Beperkte hoogte van amper 228 mm



Dankzij een speciaal ontwikkelde motor en een efficiënte koeling is de machine uiterst krachtig en tegelijkertijd compact

### NIEUW RP001GZ02

Spanning		40Vmax
Bijgeleverde accu's		-
Max. induikdiepte		60 mm
Toerental onbelast		8000 - 25000 min <sup>-1</sup>
Ø spantang - bereik		6 - 12 mm
Ø spantang - inbegrepen		6 mm, 8 mm
Gewicht		4,0 - 5,2 kg
Prijs in €	excl. btw	
	incl. btw	

## ACCESSOIRES



**NIEUW**  
D-78318  
22-delige frezenset (6 mm)



D-74778  
22-delige frezenset (8 mm)



## COMPRESSOR

**BL** MOTOR **XGT** **40V** **Li-ion** max



### AC001GZ

Spanning	36V (40Vmax)	
Bijgeleverde accu's	-	
Debiet	34 l/min @ 6,0 bar	
Inschakeldruk	7,2 bar	
Uitschakeldruk	9,4 bar	
Uitgangsdruk	0 - 9,3 bar	
Geluidsdrumniveau	68 dB(A)	
Tankinhoud	7,6 L	
Gewicht	10,1 - 12,8 kg	
Prijs in €	excl. btw	
	incl. btw	

## ACCU MINIBRADPISTOOL 18 GA

**BL** MOTOR **XGT** **40V** **Li-ion** max



### FN001GZ02 FN001GA202

Spanning	36 V (40Vmax)	36 V (40Vmax)
Bijgeleverde accu's	-	2x BL4020
Bijgeleverde lader	-	DC40RA
Lengte nagels	15 - 40 mm	15 - 40 mm
Capaciteit magazijn	100	100
Makpac	✓	✓
Gewicht	2.6 - 3.2 kg	2.6 - 3.2 kg
Prijs in €	excl. btw	
	incl. btw	

## ACCU AFWERKINGSPISTOOL 23 GA

**BL** MOTOR **XGT** **40V** **Li-ion** max

- Werkt sneller dankzij BL motor en herontworpen indrijvingsveer
- Mechanisme met bewegend tegengewicht voor lage terugslag

### PT001GZ01 PT001GD101

Spanning	36 V (40Vmax)	36 V (40Vmax)
Bijgeleverde accu's	-	1x BL4025
Bijgeleverde lader	-	DC40RA
Lengte nagels	15 - 35 mm	15 - 35 mm
Capaciteit magazijn	120	120
Makpac	✓	✓
Gewicht	2.4 - 3.0 kg	2.4 - 3.0 kg
Prijs in €	excl. btw	
	incl. btw	



# NEXT GENERATION TECHNOLOGY

## EXCENTER ACCUSCHUURMACHINES



Gemakkelijke aansluiting van de voedingskabel via een connector



BO001CG en BO002CG zijn met een schuuruitslag van 5 mm hoogst efficiënt



Een padbeschermer beperkt de slijtage van de schuurzool zodat deze langer mee gaat.

- Speciaal ontwerp met handgreep achteraan
- Uiterst compact en licht; de batterij is via een kabel verbonden met de machine.
- Laag zwaartepunt en optimaal uitgebalanceerde machine. Dit resulteert in een aangenaam, natuurlijk handgevoel bij delicaat schuurwerk.
- De machine is via een connector gemakkelijk te koppelen, zo kan snel geschakeld worden tussen verschillende machines aangepast aan elke toepassing.
- Stofopvang d.m.v. het ingebouwd stofopvangsysteem met stofzak of door aansluiting van een stofzuiger.
- Compatibel met een nieuwe reeks schuurshijven van het gaastype.

	NIEUW BO001CGZ	NIEUW BO002CGZ	NIEUW BO003CGZ	NIEUW BO004CGZ	NIEUW BO005CGZ	NIEUW BO006CGZ
Spanning	36 V (40Vmax)	36 V (40Vmax)	36 V (40Vmax)	36 V (40Vmax)	36 V (40Vmax)	36 V (40Vmax)
Bijgeleverde accu's	-	-	-	-	-	-
Bijgeleverde lader	-	-	-	-	-	-
Schuurzool	Ø 125 mm	Ø 150 mm	Ø 125 mm	Ø 150 mm	Rechthoekig 80 x 130 mm	Delta 100 x 150 mm
Schuurbewegingen	6000 - 10000 min <sup>-1</sup>	6000 - 10000 min <sup>-1</sup>	6000 - 10000 min <sup>-1</sup>	6000 - 10000 min <sup>-1</sup>	6000 - 10000 min <sup>-1</sup>	6000 - 10000 min <sup>-1</sup>
Schuuruitslag	5 mm	5 mm	3 mm	3 mm	3 mm	3 mm
Vibratieniveau	3,2 m/s <sup>2</sup>	2,7 m/s <sup>2</sup>	2,9 m/s <sup>2</sup>	2,5 m/s <sup>2</sup>	2,6 m/s <sup>2</sup>	2,6 m/s <sup>2</sup>
AWS	✓	✓	✓	✓	✓	✓
Gewicht	0,92 kg	0,98 kg	0,91 kg	0,96 kg	0,93 kg	0,93 kg
Prijs in €	excl. btw					
	incl. btw					

## SCHUURNETTEN

Afmeting	Korrel	Omschrijving	Artikelnummer	Verpakt per	Prijs excl. btw	Prijs incl. btw
125 mm	K80	Schuurnet	D-78651	10		
	K120	Schuurnet	D-78667	10		
	K180	Schuurnet	D-78673	10		
	K240	Schuurnet	D-78689	10		
	K320	Schuurnet	D-78695	10		
150 mm		Padbeschermer	D-78704	2		
	K80	Schuurnet	D-78710	10		
	K120	Schuurnet	D-78726	10		
	K180	Schuurnet	D-78732	10		
	K240	Schuurnet	D-78748	10		
	K320	Schuurnet	D-78754	10		
		Padbeschermer	D-78760	2		
80 mm x 130 mm"	K80	Schuurnet	D-78776	10		
	K120	Schuurnet	D-78782	10		
	K180	Schuurnet	D-78798	10		
	K240	Schuurnet	D-78807	10		
	K320	Schuurnet	D-78813	10		
100 mm x 150 mm"		Padbeschermer	D-78829	2		
	K80	Schuurnet	D-78891	10		
	K120	Schuurnet	D-78900	10		
	K180	Schuurnet	D-78916	10		
	K240	Schuurnet	D-78922	10		
	K320	Schuurnet	D-78938	10		
		Padbeschermer	D-78944	2		

NIEUW



- De netstructuur zorgt voor een zeer hoge efficiëntie bij het schuren!
- Optimale stofafzuiging via de netstructuur!
- Uiterst gemakkelijk te installeren in combinatie met de velcro padbeschermer

COMBOPACK XGT



**NIEUW**

**DK0114G205**

Bijgeleverde accu's	2 x BL4040
Bijgeleverde lader	DC40RA
Klopboor- en schroefmachine	HP001G
Slagschroevendraaier	TD001G
Verpakking	Makpac
Prijs in €	excl. btw
	incl. btw

COMBOPACK XGT



Promo: gratis extra accu 2,5 Ah

**DK0124G201**

Bijgeleverde accu's	2 x BL4040
Bijgeleverde lader	DC40RA
Boor- en schroefmachine	DF001G
Haakse slijper 125 mm	GA005G
Verpakking	Makpac
Prijs in €	excl. btw
	incl. btw

COMBOPACK XGT



Promo: gratis extra accu 4,0 Ah

**DK0125G301**

Bijgeleverde accu's	2 x BL4040
Bijgeleverde lader	DC40RA
Boor- en schroefmachine	DF001G
Slagschroevendraaier	TD001G
Haakse slijper 125 mm	GA005G
Verpakking	Makpac
Prijs in €	excl. btw
	incl. btw



# NEXT GENERATION TECHNOLOGY

COMBOPACK XGT

XGT  
40V LITHIUM max

Promo: gratis extra  
accu 4,0 Ah + extra  
lader DC40RA



DK0126G401

Bijgeleverde accu's	2 x BL4040
Bijgeleverde lader	DC40RA
Haakse slijper 125 mm	GA005G
Reciprozaag	JR001G
Boor- en schroefmachine	DF001G
Slagschroevendraaier	TD001G
Verpakking	Gereedschapstas
Prijs in €	excl. btw
	incl. btw

COMBOPACK XGT

XGT  
40V LITHIUM max



DK0128G601

Promo: gratis  
Powerpack 4,0 Ah  
t.w.v.

Bijgeleverde accu's	2 x BL4040
Bijgeleverde lader	DC40RA
Boor- en schroefmachine	DF001G
Slagschroevendraaier	TD001G
Haakse slijper 125 mm	GA005G
Reciprozaag	JR001G
SDS plus combihamer	HR002G
Cirkelzaag 190 mm	HS003G
Verpakking	Gereedschapstas
Prijs in €	excl. btw
	incl. btw

XGT-PLATFORM

**AS001GZ**

Blaas- en zuigmachine  
40Vmax

Prijs excl. BTW

Prijs incl. BTW



**CE003GZ02**

Doorslijper 230mm

Prijs excl. BTW

Prijs incl. BTW



**BO001CGZ**

Excenter schuurmachine 40Vmax 125mm,  
3mm uitslag

Prijs excl. BTW

Prijs incl. BTW



**CE004GZ**

Doorslijper 305mm

Prijs excl. BTW

Prijs incl. BTW



**BO002CGZ**

Excenter schuurmachine 40Vmax 150mm,  
3mm uitslag

Prijs excl. BTW

Prijs incl. BTW



**CF002GZ**

Ventilator 40Vmax

Prijs excl. BTW

Prijs incl. BTW



**BO003CGZ**

Excenter schuurmachine 40Vmax 125mm,  
5mm uitslag

Prijs excl. BTW

Prijs incl. BTW



**CL001GZ05**

Stelstofzuiger 40Vmax

Prijs excl. BTW

Prijs incl. BTW



**BO004CGZ**

Excenter schuurmachine 40Vmax 150mm,  
5mm uitslag

Prijs excl. BTW

Prijs incl. BTW



**CL002GZ03**

Stelstofzuiger 40Vmax

Prijs excl. BTW

Prijs incl. BTW



**BO005CGZ**

Excenter schuurmachine  
40Vmax  
80x130mm

Prijs excl. BTW

Prijs incl. BTW



**CL002GZ07**

Stelstofzuiger 40Vmax

Prijs excl. BTW

Prijs incl. BTW



**BO006CGZ**

Excenter schuurmachine  
40Vmax 100x150mm

Prijs excl. BTW

Prijs incl. BTW



**CL003GZ04**

Stelstofzuiger 40Vmax

Prijs excl. BTW

Prijs incl. BTW



**CS002GZ**

Metaalcirkelzaag  
40Vmax

Prijs excl. BTW

Prijs incl. BTW



**CE001GZ**

Accu doorslijper  
355 mm

Prijs excl. BTW

Prijs incl. BTW



**DA001GZ01**

Haakse boormachine  
40Vmax

Prijs excl. BTW

Prijs incl. BTW



**CE002GZ01**

Accu doorslijper  
355 mm

Prijs excl. BTW

Prijs incl. BTW



**DF001GZ01**

Boor- en schroef-  
machine 40Vmax

Prijs excl. BTW

Prijs incl. BTW



**DF002GZ01**

Boor- en schroefmachine  
40Vmax

Prijs excl. BTW

Prijs incl. BTW



**FN001GZ02**

Minibradpistool 40Vmax

Prijs excl. BTW

Prijs incl. BTW



**GA013GZ01**

Haakse slijper  
125 mm 40Vmax

Prijs excl. BTW

Prijs incl. BTW



**GA029GZ**

Haakse slijper  
125 mm 40Vmax

Prijs excl. BTW

Prijs incl. BTW



**GA038GZ01**

Haakse slijper  
230 mm 40Vmax

Prijs excl. BTW

Prijs incl. BTW



**GA041GZ**

X-Lock haakse slijper  
125 mm 40Vmax

Prijs excl. BTW

Prijs incl. BTW



**GA044GZ**

X-Lock haakse slijper  
125 mm 40Vmax

Prijs excl. BTW

Prijs incl. BTW



**HM004GZ01**

Breekhamer 80Vmax

Prijs excl. BTW

Prijs incl. BTW



**HP001GZ01**

Klopboor- en schroefmachine  
40Vmax

Prijs excl. BTW

Prijs incl. BTW



**HP002GZ01**

Klopboor- en schroefmachine  
40Vmax

Prijs excl. BTW

Prijs incl. BTW



**HR002GZ02**

SDS-PLUS Combihamer 40Vmax

Prijs excl. BTW

Prijs incl. BTW



**HR005GZ01**

SDS-Max Combihamer 40Vmax

Prijs excl. BTW

Prijs incl. BTW



**HR006GZ**

SDS-Max Combihamer 40Vmax

Prijs excl. BTW

Prijs incl. BTW



**HR007GZ01**

SDS-PLUS Combihamer 40Vmax

Prijs excl. BTW

Prijs incl. BTW



**HR009GZ02**

SDS-PLUS Combihamer 40Vmax

Prijs excl. BTW

Prijs incl. BTW



**HS004GZ**

Cirkelzaag 190 mm 40Vmax

Prijs excl. BTW

Prijs incl. BTW



**HS009GZ**

Cirkelzaag 190 mm 40Vmax

Prijs excl. BTW

Prijs incl. BTW



**HS010GZ**

Cirkelzaag  
235 mm 40Vmax

Prijs excl. BTW

Prijs incl. BTW



**HS011GZ**

Cirkelzaag 270 mm 40Vmax

Prijs excl. BTW

Prijs incl. BTW





PRIJZEN GELDIG T.E.M. 31/12/2024

## HS012GZ01

Cirkelzaag 165 mm  
40Vmax

Prijs excl. BTW

Prijs incl. BTW



## LS004GZ01

Accu afkort- verstekzaag XGT

Prijs excl. BTW

Prijs incl. BTW



## RT001GZ16

Boven- en kantenfrees 40Vmax

Prijs excl. BTW

Prijs incl. BTW



## TW007GZ01

Slagmoersleutel 40Vmax

Prijs excl. BTW

Prijs incl. BTW



## JR001GZ

Reciprozaag  
40Vmax

Prijs excl. BTW

Prijs incl. BTW



## MP001GZ

Luchtpomp 40Vmax

Prijs excl. BTW

Prijs incl. BTW



## SP001GZ03

Invalcirkelzaag 40Vmax

Prijs excl. BTW

Prijs incl. BTW



## UT001GZ02

Menger  
40Vmax

Prijs excl. BTW

Prijs incl. BTW



## JR002GZ

Reciprozaag  
40Vmax

Prijs excl. BTW

Prijs incl. BTW



## PB002GZ

Bandzaag 40Vmax

Prijs excl. BTW

Prijs incl. BTW



## TD003GZ01

Slagschroevendraaier 40Vmax

Prijs excl. BTW

Prijs incl. BTW



## VC002GLZ01

Stofzuiger  
40Vmax

Prijs excl. BTW

Prijs incl. BTW



## KP001GZ01

Schaaf  
40Vmax

Prijs excl. BTW

Prijs incl. BTW



## PT001GZ01

Pinpistool 40Vmax

Prijs excl. BTW

Prijs incl. BTW



## TM001GZ02

Multitool 40Vmax

Prijs excl. BTW

Prijs incl. BTW



## VC003GLZ

Stofzuiger  
40Vmax

Prijs excl. BTW

Prijs incl. BTW



## KT001GZ

Waterkoker  
40Vmax

Prijs excl. BTW

Prijs incl. BTW



## PV001GZ

Polijsmachine 40Vmax

Prijs excl. BTW

Prijs incl. BTW



## TM001GZ03

Multitool 40Vmax

Prijs excl. BTW

Prijs incl. BTW



## VC005GLZ

Stofzuiger  
40Vmax

Prijs excl. BTW

Prijs incl. BTW



## LS002GZ01

Radiale afkortzaag XGT

Prijs excl. BTW

Prijs incl. BTW



## RP001GZ02

Accu bovenfrees

Prijs excl. BTW

Prijs incl. BTW



## TW001GZ01

Slagmoersleutel XGT

Prijs excl. BTW

Prijs incl. BTW



## VR003GZ

Betontrilnaald  
40Vmax

Prijs excl. BTW

Prijs incl. BTW



## LS003GZ01

Accu afkort- verstekzaag XGT

Prijs excl. BTW

Prijs incl. BTW



## RS001GZ

Wormzaag 185 mm 40Vmax

Prijs excl. BTW

Prijs incl. BTW



## TW002GZ

Slagmoersleutel 40Vmax

Prijs excl. BTW

**Coming soon !**

Prijs incl. BTW



## VR004GZ

Betontrilnaald  
40Vmax

Prijs excl. BTW

Prijs incl. BTW



## 191L77-9

Powerpack XGT®  
BL4040

Prijs excl. BTW

Prijs incl. BTW



**STUNT  
PRIJZEN!**

Prijzen geldig  
t.e.m. 31/12/2024

## 1911V6-0

Powerpack XGT®  
BL4050F

Prijs excl. BTW

Prijs incl. BTW



**STUNT  
PRIJZEN!**

Prijzen geldig  
t.e.m. 31/12/2024



Prijzen geldig t.e.m. 31/12/2024

1. CHOOSE YOUR BODY!

2. CHOOSE YOUR POWER!

3. MIX IT UP!

**XGT**  
Power 2 Choose

**XGT**  
**40V Li-ion max**

191L29-0

Li-ion accu BL4020  
40Vmax • 2,0 Ah • 0,69 kg • 22 min\*



191B36-3

Li-ion accu BL4025  
40Vmax • 2,5 Ah • 0,71 kg • 28 min\*



191B26-6

Li-ion accu BL4040  
40Vmax • 4,0 Ah • 1,0 kg • 45 min\*



1910N6-8

Li-ion accu BL4040F  
40Vmax • 4,0 Ah • 1,0 kg • 45 min\*



191L47-8

Li-ion accu BL4050F  
40Vmax • 5,0 Ah • 1,3 kg • 50 min\*



191X65-8

Li-ion accu BL4080F  
40Vmax • 8,0 Ah • 2,0 kg • 80 min\*



191J81-6

XGT Powerpack 2,5 Ah



191J65-4

XGT Powerpack 4,0 Ah



191L77-9

XGT Powerpack 4,0 Ah



STUNTPRIJS

1911V6-0

XGT Powerpack 5,0 Ah



STUNTPRIJS

191U00-8

XGT Powerpack 4,0 Ah



191U28-6

XGT Powerpack 4,0 Ah



191U13-9

XGT Powerpack 5,0 Ah



191U42-2

XGT Powerpack 5,0 Ah



191Y97-1

XGT Powerpack 8,0 Ah



DEAADP001G

ADP001 Laadadapter

USB-adapter voor XGT 40Vmax accu's



191E07-8

Oplader DC40RA

Snellader voor XGT 40Vmax accu's



191N09-8

Duo snellader DC40RB

Duo snellader voor het gelijktijdig laden van twee XGT 40Vmax accu's



191C10-7

ADP10 Laadadapter

Adapter om LXT 14,4 V en 18 V accu's te laden op een XGT 40Vmax lader



1911L9-4

Duo oplader DC40WA

Traaglader voor XGT 40Vmax accu's



1910D9-2

Communicatieadapter ADP12

Adapter om XGT-machines te verbinden met smartphone, laptop,...

\* de adapter wordt enkel tussen machine en accu geplaatst tijdens controle / bij het maken van de gewenste instellingen



- Diefstalbeveiliging instellen d.m.v. een pincode
- De werkingsduur van accu's instellen
- De gebruikshistoriek van de XGT-machines raadplegen

\* Laadtijd met DC40RA

# BL4040F

## GEAVANCEERDE "HIGH PERFORMANCE" ACCU



De nieuwe geavanceerde BL4040F accu is uiterst krachtig en tegelijkertijd ook compact en licht.

- Hoger vermogen, in de praktijk betekent dit bijvoorbeeld dat het toerental van de machine minder zal terugvallen bij zware belasting.
- Minder opwarming, en in extreme situaties dus ook minder kans op uitval door oververhitting.
- Een betere autonomie omdat het energieverlies kleiner is. Je kan dus langer werken op één acculading.
- De BL4040 en BL4040F hebben dezelfde compacte afmetingen en wegen exact even veel.
- Het piekvermogen van de BL4040F benadert dat van de grotere BL4050F.
- De energiecapaciteit van de BL4040 als BL4040F is hetzelfde (144 Wh), maar in praktijk echter blijkt de autonomie van de BL4040F groter omdat het energieverlies bij het ontladen kleiner is.
- De energiecapaciteit van de BL4050F is nog steeds groter, maar deze accu is ook groter en zwaarder dan de BL4040F.

### Specifieke toepassingen

De BL4040F is een uitstekende keuze wanneer een hoog piekvermogen vereist is en de batterij tegelijkertijd ook zo licht en compact mogelijk moet zijn.

Enkele voorbeelden zijn haakse slijpers, boorhamers, cirkelzagen, en (tophandle) kettingzagen.



"Tabless" Li-ion batterijcellen hebben een innovatieve opbouw waarbij er veel meer stroompaden zijn tussen de anode en de kathode van de cel. In plaats van slechts twee verbindingpunten of "tabs" wordt in het nieuwe ontwerp de hele boven- en onderkant van de batterij als elektrode gebruikt. Daardoor neemt de interne weerstand sterk af met als gevolg een hogere piekstroom en minder warmteontwikkeling.

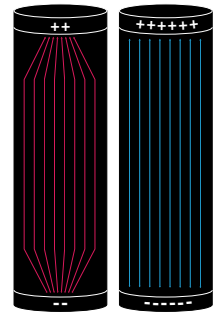

✓ HOOG VERMOGEN

✓ MINDER OPWARMING

✓ LICHT EN COMPACT

✓ BETERE AUTONOMIE

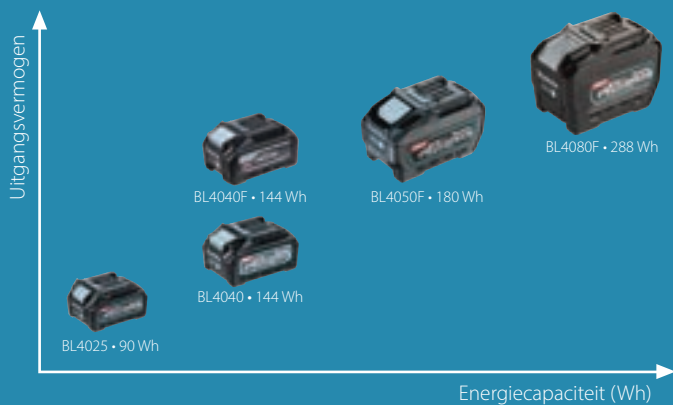

	BL4040	BL4040F	BL4050F
Referentie	191B26-6	1910N6-8	191L47-8
Energiecapaciteit	144 Wh	144 Wh	180 Wh
Piekvermogen *	1,5 kW	2,1 kW	2,2 kW
Gewicht	1,0 kg	1,0 kg	1,4 kg
Prijs in €**	excl. btw		
	incl. btw		

\* Het maximum vermogen dat gedurende 3 s geleverd kan worden  
\*\* Prijzen geldig t.e.m. 31/12/2024





**XGT**

# 40V Li-ion max

*Hoog vermogen*

*Robuust*

*Digitale  
communicatie*



**XGT**

## 40V Li-ion max

**XGT X2**  
80V max



Accu

BL4020  
2.0Ah

BL4025 /  
BL4025F  
2.5Ah

BL4040 /  
BL4040F  
4.0Ah





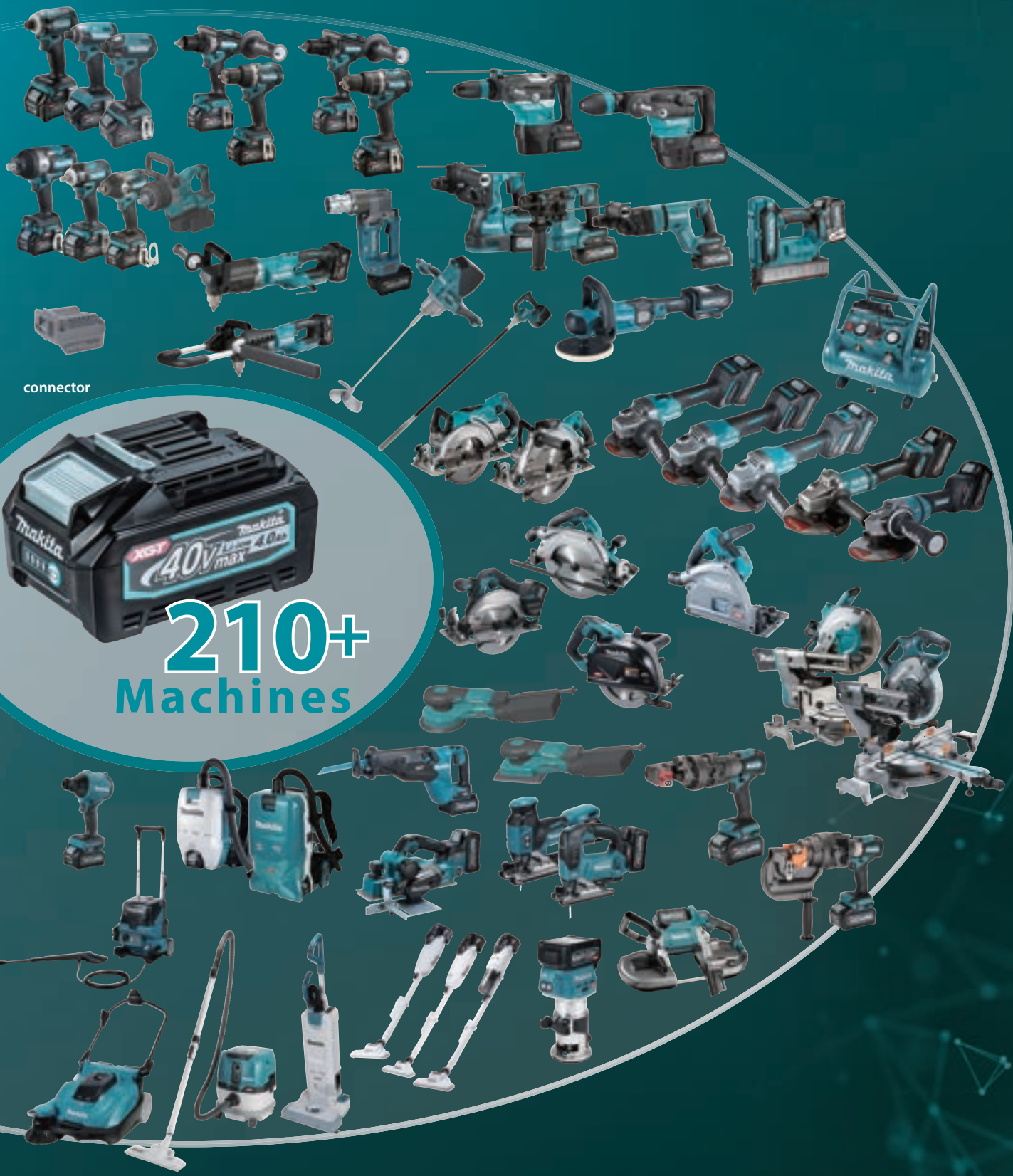

connector



**210+**  
Machines

Lader

BL4050F  
5.0Ah

BL4080F  
8.0Ah

DC40RA

DC40RB

DC40WA

DC40RC

ADP10



Adapter voor  
LXT Batterij

# LXT-Platform

Betrouwbaar – veelzijdig – krachtig

## Snel en optimaal laden

Wanneer de batterijen warm zijn, dan is het belangrijk dat die eerst gekoeld worden vooraleer het laadtraject te starten. De lader is uitgerust met een ventilator die de batterijen koelt vóór en tijdens het laden om de laadtijd te verkorten.

Makita geavanceerd laadsysteem  
Geforceerde koeling



Snelladen



Standaard laadsysteem  
Natuurlijke warmteafvoer



Langere laadtijd



**3.0Ah**  
**Li-ion**

22 minuten

3,0 Ah  
BL1830B

SNELSTE LAADTIJD

**4.0Ah**  
**Li-ion**

36 minuten

4,0 Ah  
BL1840B

**5.0Ah**  
**Li-ion**

45 minuten

5,0 Ah  
BL1850B

**6.0Ah**  
**Li-ion**

55 minuten

6,0 Ah  
BL1860B

LANGSTE WERKDUUR







**18V**  
LITHIUM-ION

**18V + 18V**

**36V**

**LXT**

Met de uitgebreide LXT-serie biedt Makita een accu voor meer dan 420 machines en tuingereedschap dat werkt op 18 V en 2 x 18 V. Het voortdurend groeiende LXT-platform biedt professionele oplossingen voor elke klus

PRIJZEN GELDIG T.E.M. 31/12/2024

**197280-8**  
accu BL1850B 18V 5,0 Ah



**197288-2**  
TWINPACK 18V 2 x 5,0 Ah



**197422-4**  
accu BL1860B 18V 6,0 Ah



**DECADP05**  
USB-adapter  
USB-adapter voor 14,4V/18V accu's



**197494-9**  
POWERPACK 18V 2 x 4,0 Ah



**197624-2**  
POWERPACK 18V 2 x 5,0 ah



**197629-2**  
POWERPACK 18V 2 x 5,0 Ah



**197626-8**  
POWERPACK 18V 4 x 5,0 Ah



**198116-4**  
Powerpack 18V 2 x 6,0 Ah



**198077-8**  
POWERPACK 18V 2 x 6,0 Ah



**198091-4**  
POWERPACK 18V 4 x 6,0 Ah



**198170-8**  
Accu timer LXT BPS01  
Programmeert de werksduur van 14,4V & 18V accu's



**195584-2**  
OPLADER DC18RC  
Snellader voor LXT accu's van 14,4/18V



**196933-6**  
DUBBELLADER DC18RD  
Duo snellader voor LXT accu's: 14,4/18V



2 accu's BL1850 laden  
in 45 minuten

**196426-3**  
Oplader DC18SF  
Traaglader voor LXT accu's, 4 poorten  
Laadt twee accu's tegelijk op





# Het grootste 18 V Lithium-ion assortiment ter wereld.

Meer dan 440 machines met slechts één accu.

**18V**  
**LITHIUM-ION**

**3**  
JAAR  
**GARANTIE**  
OP MACHINES  
Na registratie op  
[www.makita.be](http://www.makita.be)

**LXT**

Lithium-Ion Extreme Technology

- + Performante Lithium-Ion accu's
- + Een unieke en snelle oplaadtechnologie
- + Energie-efficiënte koolborstelloze motoren
- + Meervoudige bescherming tegen overbelasting





Kettingzaag

Hoogsnoeier

Grastrimmer

Grasmaaiers

Snoeischaar

Grondbegraaf

Bladblazers

Draagbaar accupack

Haagschaar

Hogedrukreiniger

Vacuum pomp

Slagmoersleutels

Stofzuigers

Waterkoker

Combisysteem

Ruggedragen stofzuigers

Staannde stofzuiger

Menger

Boormachine

Slagschroevendraaiers

2x 18V

Schroefautomaten

Haakse slag-schroevendraaiers

Slagschroevendraaiers

Schroefmachines

Klopboormachines

Ratelmoeisleutel

Haakse boormachines

Boor- en schroefmachines

Bijknemer

Boorhamers

18V

Betonijzerzaag

Plaatschaar

Combihamers SDS-plus

Boven- en kantenfrees

Reciprozagen

Multitool

Knabbelschaar

Schuurpolijst-machine

Draadstangknippers

Zaagmachines

Bandzagen

Gipszaag

Cirkelzagen

Handpalm-schuurmachines

Polijstmachines

Metaalcirkelzagen

Bandschuurmachine

Langnek-schuurmachine

Handpalm-schuurmachines

Polijstmachines

Lamellenfrees

Decoupeerzagen

Afkort-verstekzagen

Haakse slijper





ACCU (KLOP-)BOOR- EN SCHROEFMACHINE



DHP453RFX2

incl. 96 accessoires



**PROMO**  
gratis thermosfles  
+ houder E-05599

DHP453RFX2

Spanning	18 V	
Bijgeleverde accu's	2 x BL1830B	
Hard koppel	42 Nm	
Boorkop	1,5-13 mm	
Gewicht	1,7 kg	
Prijs in €	excl. btw	
	incl. btw	

ACCU (KLOP-)BOOR- EN SCHROEFMACHINES



DDF484RT3J



DDF486RT3J

Uitgeleverd met 3 accu's!

	DDF453RF3J	DDF482RT3J	DDF484RT3J	DDF486RT3J	DHP486RT3J
Spanning	18 V	18 V	18 V	18 V	18 V
Bijgeleverde accu's	3 x BL1830B	3 x BL1850B	3 x BL1850B	3 x BL1850B	3 x BL1850B
BL-motor	-	-	✓	✓	✓
Klopboorfunctie	-	-	-	-	✓
Hard koppel	42 Nm	62 Nm	54 Nm	130 Nm	130 Nm
Boorkop	1,5-13 mm	1,5-13 mm	1,5-13 mm	1,5 - 13 mm	1,5 - 13 mm
Gewicht	1,7 kg	1,7 kg	1,5 kg	2,3 - 2,6 kg	2,3 - 2,7 kg
Prijs in €	excl. btw				
	incl. btw				



ACCU (KLOP-)BOOR- EN SCHROEFMACHINES



**DDF489/DHP489**

- Uiterst krachtige en compacte machine voor all-round gebruik
- Volledig metalen boorkop



PROMO

	DDF083ZJ	DDF487RAJ	DDF489RTJ
Spanning	18 V	18 V	18 V
Bijgeleverde accu's	-	2 x BL1820	2 x BL1850B
Klopboorfunctie	-	-	-
Hard koppel	40 Nm	40 Nm	50 Nm
Opname	1/4 hex	1,5 - 13 mm	1,5-13 mm
Gewicht	1,1 - 1,4 kg	1,3 - 1,6 kg	1,4 kg
Prijs in €	excl. btw		
	incl. btw		

Wist je dat er van DDF484 en DHP486 ook de voordelige uitvoeringen DDF484Z / DDF484T1J en DHP486Z / DHP486T1J bestaan? Zie p. 68-69 voor meer info!

	PROMO OP = OP DDF484RTE	PROMOPRIJS DDF484RTJ	PROMOPRIJS DDF489RTJ	PROMOPRIJS DDF486RTJ	PROMOPRIJS DHP487RAJ	PROMOPRIJS DHP485RFJ	PROMOPRIJS DHP484RTJ	PROMOPRIJS DHP489RTJ	PROMOPRIJS DHP486RT3J
Spanning	18 V	18 V	18 V	18 V	18 V	18 V	18 V	18 V	18 V
Bijgeleverde accu's	2 x BL1850B	2 x BL1850B	2 x BL1850B	2 x BL1850B	2 x BL1820	2 x BL1830B	2 x BL1850B	2 x BL1850B	3 x BL1850B
Klopboorfunctie	-	-	-	-	✓	✓	✓	✓	✓
Hard koppel	54 Nm	54 Nm	73 Nm	130 Nm	40 Nm	50 Nm	54 Nm	73 Nm	130 Nm
Opname	1,5-13 mm	1,5-13 mm	1,5-13 mm	1,5-13 mm	1,5 - 13 mm	1,5-13 mm	1,5-13 mm	1,5 - 13 mm	1,5 - 13 mm
Gewicht	1,6 - 2,2 kg	1,6 - 2,2 kg	1,8 - 2,5 kg	2,3 - 2,7 kg	1,3 - 1,6 kg	1,4 - 1,7 kg	1,6 - 2,2 kg	1,8 - 2,5 kg	2,3 - 2,7 kg
Prijs in €	excl. btw								
	incl. btw								

ACCU HAAKSE BOORMACHINES



	DDA350ZJ	DDA351RTJ	DDA450RTE	DDA460ZK
Spanning	18 V	18 V	18 V	2 x 18 V
Bijgeleverde accu's	-	2 x BL1850B	2 x BL1850B	-
Toerental	0-1800 t.p.m.	0-1800 t.p.m.	0 - 450 t.p.m. 0 - 1400 t.p.m.	0-350 t.p.m. 0-1400 t.p.m.
BL motor	-	-	✓	✓
XPT	-	-	✓	✓
Hard koppel	13,7 Nm	13,7 Nm	26/70 Nm	70/136 Nm
Boorkop	1,5-10 mm	1,5-10 mm	1,5-13 mm	1,5-13 mm
Gewicht	1,8 kg	1,8 kg	3,2 kg	5,7 kg
Prijs in €	excl. btw			
	incl. btw			



DDA350RTJ

ACCU BIKHAMER SDS-PLUS



DHR180RTJ



		DHR180ZJ	DHR180RTJ
Spanning		18V	18V
Bijgeleverde accu's		0	2 x BL1850B
Slagenergie		3,1 J	3,1 J
Slagfrequentie		0 - 3200/min	0 - 3200/min
Triaxiale vibratiewaarde (ah)		4,5 m/s <sup>2</sup>	4,5 m/s <sup>2</sup>
Gewicht		3,3 kg	3,3 kg
Prijs in €	excl. btw		
	incl. btw		

ACCU BOORHAMERS SDS-PLUS



DHR171RTJ



**PROMO**

DHR243RTJ  
Gratis 3e accu  
5 Ah BL1850B



DHR202RTJ



DHR182RTWJ



DHR243RTJ



DHR183RTWJ

DHR182RTWJ  
DHR243RTWJ  
DHR183RTWJ  
incl. STOF AFZUIGING



**PROMO**

		DHR171RTJ	DHR183RTWJ	DHR202RTJ	DHR182RTJ	DHR182RTWJ	DHR243RTJ	DHR243RTWJ
Spanning		18V	18V	18V	18V	18V	18V	18V
Bijgeleverde accu's		2 x BL1850B	2 x BL1850B	2 x BL1850B	2 x BL1850B	2 x BL1850B	2 x BL1850B	2 x BL1850B
Slagenergie		1,2 J	1,7 J	2 J	1,7 J	1,7 J	2 J	2 J
Max. Ø beton		16 mm	16 mm	20 mm	18 mm	18 mm	24 mm	24 mm
BL-motor		✓	✓	-	✓	✓	✓	✓
AVT		-	✓	-	✓	✓	-	-
AWS		-	-	-	✓ excl. Bluetooth unit	✓ excl. Bluetooth unit	-	-
Stofafzuigingsysteem		-	DX16	-	-	DX05	-	DX07
Gewicht		2,1 kg	2,1 - 2,8 kg	3,5 kg	2,4 kg	3,3 kg	3,2 kg	4,7 kg
Prijs in €	excl. btw							
	incl. btw							

Wist je dat er van DHR243 ook de voordelige uitvoeringen DHR243Z en DHR243T1J bestaan? Zie p. 68-69 voor meer info!

# Technologie

## AFT

### Active feedback sensing technology

Deze technologie schakelt de motor onmiddellijk uit bij het plots blokkeren van de machine. Sommige machines maken daarbij gebruik van een accelerometer die de zwenkbeweging van de machine detecteert. De AFT-technologie verhoogt de veiligheid enorm.

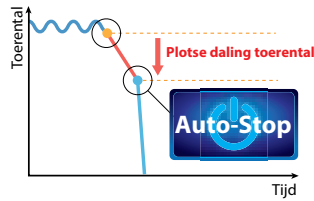

## AVT

### Anti-vibration technology

Het AVT-systeem reduceert trillingen drastisch door het gebruik van een systeem met bewegend tegengewicht, hetgeen het gebruikscomfort sterk verbetert.

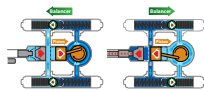

### Auto-start wireless system

Dankzij AWS wordt de stofafzuiging bij accu-toestellen automatisch geactiveerd d.m.v. een Bluetooth®-verbinding.



## ACCU COMBIHAMERS SDS-PLUS



DHR283G2JU

DHR264PT2J

Alle modellen INCLUSIEF extra automatische boorkop



**AWS**  
**AVT**  
**AFT**

DHR283ZWJU  
inclusief  
STOFAFZUIGING



	DHR264PT2J	DHR283ZJU	DHR283ZWJU	DHR283G2JU
Spanning	2 x 18V	2 x 18V	2 x 18V	2 x 18V
Bijgeleverde accu's	2 x BL1850B	0	0	2 x BL1860B
BL-motor	-	✓	✓	✓
Slagenergie	2,5 J	2,8 J	2,8 J	2,8 J
Max. Ø beton	26 mm	28 mm	28 mm	28 mm
AWS	-	✓	✓	✓
AVT	-	✓	✓	✓
AFT	-	✓	✓	✓
Stofafzuigstelsysteem	-	-	DX09	-
Gewicht	4,2 kg	4,0 kg	5,5 kg	4,0 kg
Prijs in €	excl. btw			
	incl. btw			



IMPACT BLACK KRACHTDOPPENSETS



E-16564



E-16586



E-16601



E-16639



E-16645

Artikel	Opname	Diameters (mm)	Lengte (mm)	Prijs excl. btw	Prijs incl. btw
E-16601	1/2"	8, 10, 12, 13, 14, 17, 19, 21	38		
E-16564	1/2"	8, 10, 13, 16, 17, 18, 19, 21, 24	38		
E-16586	1/2"	10, 11, 12, 13, 14, 16, 17, 19, 21, 22, 24, 27, 30, 32	81,5		
E-16645	1/2"	8, 10, 12, 13, 14, 15, 17, 18	38		
E-16639	3/8"	8, 10, 12, 13, 14, 15, 17, 18	38		

Schroefbitdoppen - Om schroeven te bevestigen met een hoog koppel met behulp van een slagmoersleutel!

Artikel	Opname	Bitmaat	Lengte (mm)	Prijs excl. btw	Prijs incl. btw
E-19794	1/2"	T30	78		
E-19803	1/2"	T35	78		
E-19819	1/2"	T40	78		
E-19825	1/2"	T45	78		
E-19831	1/2"	T50	78		
E-19847	1/2"	T55	78		
E-19853	1/2"	T60	78		



E-19803

ACCU COMBIHAMER SDS-MAX



DHR400ZKU1  
incl. stofafzuiging 199142-6

	DHR400ZKUN	DHR400ZKU1	DHR400G2UN
Spanning	2 x 18V	2 x 18V	2 x 18V
Bijgeleverde accu's	-	-	2 x BL1860B
Slagenergie	8 J	8 J	8 J
Max. Ø beton	40 mm	40 mm	40 mm
Vibratieniveau hamerboren	5,0 m/s <sup>2</sup>	5,0 m/s <sup>2</sup>	5,0 m/s <sup>2</sup>
AWS	✓	✓	✓
AFT	✓	-	✓
Gewicht	8,1 kg	8,1 kg	8,1 kg
Prijs in €	excl. btw		
	incl. btw		

ACCU HETELUCHTPISTOLEN



DHG180RT1J

DHG181RT1J

- Snelle wissel van het mondstuk
- Veilige schakelaar, te blokkeren in uit en aan stand
- Verschillende mondstukken zijn inbegrepen

	DHG180RT1J	DHG181RT1J
Spanning	18V	18V
Bijgeleverde accu's	1x BL1850B	1x BL1850B
Temperatuurbereik	550 °C	6 standen, max 550 °C
Debiet	200 l/min	120 l/min, 200 l/min
Gewicht	1,0 - 1,3 kg	1,0 - 1,4 kg
Prijs in €	excl. btw	
	incl. btw	

ACCU SLAGMOERSLEUTELS



**Auto-stop:**  
de machine stopt automatisch van zodra de bout of moer voldoende is losgedraaid

Wist je dat er van DTW300 de voordelige uitvoeringen DTW300Z en DTW300TJ bestaan? Zie p. 68-69 voor meer uitleg!



DTW1001RTJ



DTW190RTJ



DTW300RTJ



DTW700RTJ



DTW181RTJ

	DTW181RTJ	DTW190RTJ	DTW300RTJ	DTW700RTJ	DTW1001RTJ	DTW1002RTJ
Spanning	18V	18V	18V	18V	18V	18V
Bijgeleverde accu's	2 x BL1850B	2 x BL1850B	2 x BL1850B	2 x BL1850B	2 x BL1850B	2 x BL1850B
BL-motor	✓	-	✓	✓	✓	✓
XPT	✓	-	✓	✓	-	-
Toerental	0-2400 tpm.	0-2400 tpm.	0-3200 tpm.	0-2200 tpm.	0-1800 t.p.m.	0-1800 t.p.m.
Max. koppel	180 Nm	190 Nm	330 Nm	700 Nm	1250 Nm	1200 Nm
Dopaaansluiting	1/2" vierkant	1/2" vierkant	1/2" vierkant	1/2" vierkant	3/4" vierkant	1/2" vierkant
Auto-stop functie	✓	-	✓	✓	-	-
Gewicht	1,2 kg	1,4 kg	1,8 kg	2,6 kg	3,4 kg	3,3 kg
Prijs in €	excl. btw					
	incl. btw					

ACCU RATELMOERSLEUTEL



Geleverd met 1/4" & 3/8" opname

Verwijderbare kop laat toe om 13 mm moeren over de lengte van een M8 draadstang te schroeven.



DWR180ZJ

	DWR180ZJ	DWR180RA1J
Spanning	18V	18V
Bijgeleverde accu's	0	1 x BL1820B
Toerental onbelast	0-800 t.p.m.	0-800 t.p.m.
Max. koppel	47,5 Nm	47,5 Nm
Gewicht	1,2 kg	1,2 kg
Prijs in €	excl. btw	
	incl. btw	

ACCU BREEKMOERSLEUTEL



- Voor het vastdraaien van torsiebreekbouten met een hoge trekvastheid (type HTB/SHTB).
- Torsiebreekbouten worden vooral gebruikt bij industriële staalconstructies.

	DWT310ZK
Spanning	2x18V
Bijgeleverde accu's	-
Toerental onbelast	14 min <sup>-1</sup>
Max. koppel	804 Nm
Compatibiliteit HTB	M16, M20, M22
Compatibiliteit SHTB	M16, M20
Gewicht	6,5 - 7,1 kg
Prijs in €	excl. btw
	incl. btw



# Impact PREMIER

## ACCESSOIRES

# IMPACT PREMIER

**Duurzamer door de dubbele torsie!**



**E-13568**  
5-delige schroefbitset



**Past zeer nauwkeurig in de schroef.**

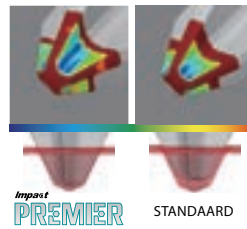

**E-03567**  
11-delige schroefbitset



**Gebruik van hoogwaardig staal. Ondersteunt een hoog koppel.**

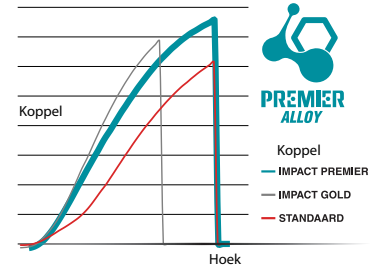

**E-13552**  
31-delige schroefbitset



Excl. BTW / Incl. BTW

Excl. BTW / Incl. BTW

- E-03121 Schroefbit IMPACT PREMIER PH1-25 mm, 2 stks
- E-03137 Schroefbit IMPACT PREMIER PH2-25 mm, 2 stks
- E-03143 Schroefbit IMPACT PREMIER PH2(slim)-25 mm, 2 stks
- E-03159 Schroefbit IMPACT PREMIER PH3-25 mm, 2 stks
- E-03165 Schroefbit IMPACT PREMIER PZ1-25 mm, 2 stks
- E-03171 Schroefbit IMPACT PREMIER PZ2-25 mm, 2 stks
- E-03187 Schroefbit IMPACT PREMIER PZ3-25 mm, 2 stks
- E-03193 Schroefbit IMPACT PREMIER T10-25 mm, 2 stks
- E-03202 Schroefbit IMPACT PREMIER T15-25 mm, 2 stks
- E-03218 Schroefbit IMPACT PREMIER T20-25 mm, 2 stks
- E-03224 Schroefbit IMPACT PREMIER T25-25 mm, 2 stks
- E-03230 Schroefbit IMPACT PREMIER T30-25 mm, 2 stks
- E-20242 Schroefbit IMPACT PREMIER T40-25 mm, 2 stks
- E-03246 Schroefbit IMPACT PREMIER PH2-25 mm, 15 stks Flip top
- E-03252 Schroefbit IMPACT PREMIER PZ2-25 mm, 15 stks Flip top

- E-03268 Schroefbit IMPACT PREMIER PH1-50 mm, 2 stks
- E-03274 Schroefbit IMPACT PREMIER PH2-50 mm, 2 stks
- E-03280 Schroefbit IMPACT PREMIER PH3-50 mm, 2 stks
- E-03296 Schroefbit IMPACT PREMIER PZ1-50 mm, 2 stks
- E-03305 Schroefbit IMPACT PREMIER PZ2-50 mm, 2 stks
- E-03311 Schroefbit IMPACT PREMIER PZ3-50 mm, 2 stks
- E-03327 Schroefbit IMPACT PREMIER T10-50 mm, 2 stks
- E-03333 Schroefbit IMPACT PREMIER T15-50 mm, 2 stks
- E-03349 Schroefbit IMPACT PREMIER T20-50 mm, 2 stks
- E-03355 Schroefbit IMPACT PREMIER T25-50 mm, 2 stks
- E-03361 Schroefbit IMPACT PREMIER T30-50 mm, 2 stks
- E-12027 Schroefbit IMPACT PREMIER T40-50 mm, 2 stks
- E-03377 Schroefbit IMPACT PREMIER PH2-50 mm, 10 stks Flip top
- E-03383 Schroefbit IMPACT PREMIER PZ2-50 mm, 10 stks Flip top



- E-06286 Dubbelbit IMPACT PREMIER PH2-65 mm, 2 stks
- E-06292 Dubbelbit IMPACT PREMIER PZ2-65 mm, 2 stks



- E-20258 IMPACT PREMIER Torsion bithouder 68 mm (magnetisch)
- E-20264 IMPACT PREMIER Torsion bithouder 150 mm (magnetisch)



- E-20270 ULTRA MAG bithouder IMPACT PREMIER TORSION (magnetisch)



- E-03420 IMPACT PREMIER Tilt adapter 1/4" voor krachtdoppen 3/8" - 50 mm
- E-03436 IMPACT PREMIER Tilt adapter 1/4" voor krachtdoppen 1/2" - 50 mm



- E-03442 IMPACT PREMIER Mag Boost magneet voor schroefbits



- E-03458 IMPACT PREMIER Torsion dopsleutel H6-65 mm
- E-03464 IMPACT PREMIER Torsion dopsleutel H8-65 mm
- E-03470 IMPACT PREMIER Torsion dopsleutel H10-65 mm
- E-03486 IMPACT PREMIER Torsion dopsleutel H13-65 mm



- E-03492 IMPACT PREMIER krachtdop H13-80 mm
- E-03501 IMPACT PREMIER krachtdop H15-80 mm
- E-03517 IMPACT PREMIER krachtdop H17-80 mm
- E-03523 IMPACT PREMIER krachtdop H19-80 mm
- E-03539 IMPACT PREMIER krachtdop H21-80 mm



- E-22888 IMPACT PREMIER dopsleutel 8x50 mm (niet-magnetisch)
- E-22894 IMPACT PREMIER dopsleutel 10x50 mm (niet-magnetisch)
- E-03573 11-delige IMPACT PREMIER schroefbitset





ACCU HAAKSE  
SLAGSCHROEVENDRAAIER



**DTL061RTJ**

Spanning	18 V
Bijgeleverde accu's	2 x BL1850B
Toerental	0-2000 t.p.m.
Gewicht	1,8 kg
Prijs in €	excl. btw
	incl. btw

ACCU SLAGSCHROEVENDRAAIERS



Assist mode: voor het vlot aanzetten bij het schroeven.

T-modus: instelling voor zelftappende schroeven.



DTD157ZJ



DTD153RTJ



DTD172RTJ

Wist je dat er van DTD153 de voordelige uitvoeringen DTD153Z en DTD157ZJ bestaan? Zie p. 68-69 voor meer info!

	DTD156RTJ	DTD153RTJ	DTD157ZJ	DTD154RTJ	DTD172RTJ
Spanning	18 V	18 V	18 V	18 V	18 V
Bijgeleverde accu's	2 x BL1850B	2 x BL1850B	-	2 x BL1850B	2 x BL1850B
BL-motor	-	✓	✓	✓	✓
Toerental	0-2500 t.p.m.	0-3400 t.p.m.	0-3000 t.p.m.	0-3600 t.p.m.	0-3600 t.p.m.
Max. koppel	155 Nm	170 Nm	140 Nm	175 Nm	180 Nm
Bitopname	1/4" hex.	1/4" hex.	1/4" hex.	1/4" hex.	1/4" hex.
Slagkrachtniveaus	-	-	2	3	4
T-modus	-	-	-	✓	✓
Assist mode	-	-	✓	-	✓
Gewicht	1,3 kg	1,5 kg	1,2 kg	1,5 kg	1,5 kg
Prijs in €	excl. btw				
	incl. btw				

ACCU HYBRIDE  
BOOR- EN SCHROEFMACHINE



4 modi: klopboren, boren schroeven, slagschroeven

DTP141RTJ

	DTP141ZJ	DTP141RTJ
Spanning	18 V	18 V
Bijgeleverde accu's	-	2 x BL1850B
Toerental	0-2700 t.p.m.	0-2700 t.p.m.
Gewicht	1,8 kg	1,8 kg
Prijs in €	excl. btw	
	incl. btw	

ACCU HYDRAULISCHE  
SLAGSCHROEVENDRAAIER



DTS141ZJ

Uiterst stil dankzij het unieke hydraulische impulsstelsysteem

	DTS141ZJ
Spanning	18 V
Bijgeleverde accu's	-
Toerental	0-3200 t.p.m.
Max. koppel	40 Nm
Bitopname	1/4" hex
T-modus	✓
Gewicht	1,5 kg
Prijs in €	excl. btw
	incl. btw

ACCU PINPISTOOL  
23 Ga



DPT353RTJ

Spanning	18 V
Bijgeleverde accu's	2 x BL1850B
Doorsnede nagel	0,6 mm
Lengte nagel	15-35 mm
Gewicht	2,0 kg
Prijs in €	excl. btw
	incl. btw

ACCU NIETMACHINES



DST221RTJ

DST221:  
Aluminium magazijn

DST112RTJ DST221RTJ

Spanning	18 V	18 V
Bijgeleverde accu's	2 x BL1850B	2 x BL1850B
Rugbreedte niet	10 mm	10,5 mm
Lengte niet	7-10 mm	10-22 mm
Gewicht	1,5 kg	2,1 kg
Prijs in €	excl. btw	
	incl. btw	

ACCU MINIBRADPISTOLEN  
18 Ga



DFN350RTJ



DBN500RTJ

DFN350RTJ DBN500RTJ

Spanning	18 V	18 V
Bijgeleverde accu's	2 x BL1850B	2 x BL1850B
Doorsnede nagel	1,2 mm	1,2 mm
XPT	✓	-
Lengte nagel	15-35 mm	15-50 mm
Gewicht	2,1 kg	3,2 kg
Prijs in €	excl. btw	
	incl. btw	

Voor zacht hout

ACCU BRADPISTOOL  
16 Ga



Voor zacht hout

DBN600RTJ

Spanning	18 V
Bijgeleverde accu's	2 x BL1850B
Doorsnede nagel	1,6 mm
Lengte nagel	25-64 mm
Gewicht	3,4 kg
Prijs in €	excl. btw
	incl. btw

ACCU LAMELLENFREES



DPJ180RTJ

Spanning	18 V
Bijgeleverde accu's	2 x BL1850B
Toerental	6500 t.p.m.
Gewicht	3,2 kg
Prijs in €	excl. btw
	incl. btw

ACCU SCHAAF



DKP181RTJU

DKP181RTJU

Spanning	18 V
Bijgeleverde accu's	2 x BL1850B
Toerental	12000 t.p.m.
Schaafbreedte	82 mm
Max. spaanafname	3 mm
Sponningdiepte	25 mm
AWS	✓
Gewicht	3,3 kg
Prijs in €	excl. btw
	incl. btw

ACCU RECIPROZAGEN



**DJR189**

- Kan met één hand gebruikt worden
- Uitstekend geschikt voor het zagen in nauwe ruimten en in de hoogte
- Uitermate licht en toch zeer krachtig
- Trillingsarm (anti-vibratiesysteem met bewegend tegengewicht)

	DJR189ZJ	DJR183RTJ	DJR186RTE	DJR187RTE	DJR188RTJ	DJR360PT2
Spanning	18V	18V	18V	18V	18V	2 x 18V
Bijgeleverde accu's	-	2 x BL1850B	2 x BL1850B	2 x BL1850B	2 x BL1850B	2 x BL1850B
Bijgeleverde lader	-	DC18RC	DC18RC	DC18RC	DC18RC	DC18RD
BL-motor	✓	-	-	✓	✓	✓
Toerental	0-3100 /min	0-3300 /min	0-2800 /min	0-3000 /min	0-3000 /min	0-3000 /min
Slaglengthe	22 mm	13 mm	32 mm	32 mm	20 mm	32 mm
Max. capaciteit hout	255 mm	50 mm	255 mm	255 mm	255 mm	255 mm
Gewicht	2,2 - 2,5 kg	1,6 kg	3,5 kg	3,4 kg	2,9 kg	4,6 kg
Prijs in €	excl. btw					
	incl. btw					

ACCU DECOUPEERZAGEN



Wist je dat er van DJV181 en DJ182 de voordelige uitvoeringen DJV181Z / DJV181T1J en DJV182Z / DJV182T1J bestaan? Zie p. 68-69 voor meer info!

	DJV184RTJ	DJV185RTJ	DJV181RTJ	DJV182RTJ
Spanning	18V	18V	18V	18V
Bijgeleverde accu's	2 x BL1850B	2 x BL1850B	2 x BL1850B	2 x BL1850B
BL motor	✓	✓	✓	✓
Aantal zaagbewegingen	0-3000 min <sup>-1</sup>	800-3000 min <sup>-1</sup>	800-3500 min <sup>-1</sup>	800-3500 min <sup>-1</sup>
Max. capaciteit hout	135 mm	135 mm	135 mm	135 mm
Slaglengthe	23 mm	23 mm	26 mm	26 mm
Gewicht	2,1 - 2,4 kg	2,0 - 2,3 kg	2,3 - 2,6 kg	2,4 - 2,7 kg
Prijs in €	excl. btw			
	incl. btw			



ACCU INVALCIRKELZAGEN  
165 mm

18V → 18V → 36V



Geleiderail  
194368-5 bij PT2J1



DSP600PT2J1

DSP601ZJU DSP600PT2J DSP600PT2J1

	DSP601ZJU	DSP600PT2J	DSP600PT2J1
Spanning	2 x 18 V	2 x 18 V	2 x 18 V
Bijgeleverde accu's	0	2 x BL1850B	2 x BL1850B
Zaagdiepte	56 mm	56 mm	56 mm
Diameter asgat	20 mm	20 mm	20 mm
AWS	✓	-	-
Aantal MAK PAC-koffers	1	2	2
Gewicht	4,4 kg	4,4 kg	4,4 kg
Prijs in €	excl. btw		
	incl. btw		

ACCU METAALCIRKELZAGEN



18V  
LITHIUM-ION



DCS552RTJ

DCS553RTJ

DCS552RTJ DCS553RTJ

	DCS552RTJ	DCS553RTJ
Spanning	18 V	18 V
Bijgeleverde accu's	2 x BL1850B	2 x BL1850B
BL-motor	-	✓
Ø zaagblad	136 mm	150 mm
Zaagdiepte (90°)	50,5 mm	57,5 mm
Gewicht	2,4 kg	3,0 kg
Prijs in €	excl. btw	
	incl. btw	

ACCU CIRKELZAGEN



18V → 18V → 36V

18V  
LITHIUM-ION



DHS680RTJ

Promo DHS680RTJ:  
gratis 3e BL1850B



DHS782PT2J



DHS660RTJ



DHS900PT2

Wist je dat er van DHS680 de voordelige uitvoeringen DHS680Z en DHS680T1J bestaan? Zie p. 68-69 voor meer info!

PROMO

DHS782, DHS783 & DHS900  
passen rechtstreeks op geleiderail

	DSS501RTJ	DHS680RTJ	DHS660RTJ	DHS661RTJU	DHS630RTJ	DHS710PT2J	DHS782PT2J	DHS783T2JU	DHS900PT2
Spanning	18 V	18 V	18 V	18 V	18 V	2 x 18 V	2 x 18 V	2 x 18 V	2 x 18 V
Bijgeleverde accu's	2 x BL1850B	2 x BL1850B	2 x BL1850B	2 x BL1850B	2 x BL1850B	2 x BL1850B	2 x BL1850B	2 x BL1850B	2 x BL1850B
BL-motor	✓	✓	✓	✓	-	-	✓	✓	✓
Zaagdiepte (90°)	51 mm	57 mm	57 mm	57 mm	66 mm	68,5 mm	62,5 mm	62,5 mm	85 mm
Ø zaagblad	136 mm	165 mm	165 mm	165 mm	165 mm	190 mm	190 mm	190 mm	235 mm
AWS	-	-	-	✓	-	-	-	✓	✓
Gewicht	2,7 kg	3,3 kg	3,4 kg	3,4 kg	3,5 kg	4,7 kg	4,5 kg	4,5 kg	5,3 kg
Prijs in €	excl. btw								
	incl. btw								

excl. Bluetooth unit

ACCU AFKORT-VERSTEKZAAG



DLS600RTE



Spanning	18 V
Bijgeleverde accu's	2 x BL1850B
Ø zaagblad	165 mm
Max. zaagcapaciteit bij 90°	46 x 92 mm
Gewicht	6,6 kg
Prijs in €	excl. btw
	incl. btw



# EFFICUT

Fijner, sneller en efficiënter snijden



Scan mij voor meer info!



**Meer zaagsneden per batterijlading**



**Snel zagen**



**Langere levensduur**



**Zuivere zaagsnede**



ACCU TELESCOPISCHE AFKORT-VERSTEKZAGEN



## DXT

Deep and Exact Cutting Technology

De gepatenteerde constructie met drievoudige tandwieloverbrenging en uitsparing achter de flens laat toe om een groter deel van het zaagblad te benutten. Daardoor kunnen ook hoge plinten verticaal of in verstek afgekort worden.



DLS714N



DLS211



	DLS714NPT2	DLS111ZU	DLS211ZU
--	------------	----------	----------

	DLS714NPT2	DLS111ZU	DLS211ZU
Spanning	2 x 18 V	2 x 18 V	2 x 18 V
Bijgeleverde accu's	2 x BL1850B	0	0
Ø Zaagblad	190 mm	260 mm	305 mm
Zaagdiepte (90°)	52 mm	91 mm	107 mm
Zaagbreedte (90°)	300 mm	310 mm	363 mm
DXT	-	✓	✓
AWS	-	✓	✓
Gewicht	13,0 kg	27,3 kg	30,7 kg
Prijs in €	excl. btw		
	incl. btw		

ACCU MENGER



Ideaal voor het mengen van vloeistoffen, verf en lichte lijmsoorten.



INCLUSIEF BATTERIJCOVER

2 MECHANISCHE SNELHEDEN

DUT130RTE

Spanning	18 V
Bijgeleverde accu's	2 x BL1850B
Diameter mengblad	165 mm
Aansluiting	M12-M14
Toerental	0-350 / 0-1300 t.p.m.
Gewicht	2,5 kg
Prijs in €	excl. btw
	incl. btw

ACCU LANGNEKSCHUURMACHINE 225 MM



Accessoires

Steunschijf

Type	Ref.	Prijs excl. btw	Prijs incl. btw
Zacht	199939-3		
Medium	199940-8		
Hard	199938-5		

Schuurschijf 225 mm (per 25)

Korrel	Ref.	Prijs excl. btw	Prijs incl. btw
P40	B-68389		
P80	B-68395		
P120	B-68404		
P180	B-68410		
P220	E-02381		
P320	B-68426		



**Telescopische buis**  
De totale lengte van de machine kan aangepast worden van 1100 tot 1520 mm



**Verlengstuk**  
Met het optionele verlengstuk met steun (199937-7) kan langer comfortabel in de hoogte gewerkt worden.



DSL801ZU

DSL800ZU



De beschermkap van de DSL800 heeft één rechte kant, dat laat toe dicht langs een muur of plafond te bewegen.



De beschermkap van de DSL801 is volledig rond, dit is gunstig voor de stofafvoer.

DSL800ZU DSL801ZU

Spanning	18 V	18 V
Bijgeleverde accu's	0	0
AWS	✓	✓
Toerental onbelast	1000-1800 t.p.m.	1000-1800 t.p.m.
Diameter schuurschijf	225 mm	225 mm
Lengte	1100 -1520 mm	1100 -1520 mm
Gewicht	4,8 kg	4,8 kg
Prijs in €	excl. btw	
	incl. btw	

ACCU GIPSFREES



DCO181Z

Spanning	18 V
Bijgeleverde accu's	0
Toerental	0 - 32000 t.p.m.
AWS	✓ excl. Bluetooth unit
BL-Motor	✓
Gewicht	1,4 kg
Prijs in €	excl. btw
	incl. btw

ACCU GIPSAZAG



DSD180ZJ

Spanning	18 V
Bijgeleverde accu's	0
Slaglengte	6 mm
Gewicht	1,7 kg
Prijs in €	excl. btw
	incl. btw



ACCU SCHROEFAUTOMATEN



# DFR453 / DFR551

- De DFR453ZJ en DFR552ZJ hebben in vergelijking met DFR452 en DFR551 een lagere snelheid en meer koppel, ideaal voor het schroeven in materiaal dat meer weerstand biedt zoals hout. De DFR452/DFR551 zijn best geschikt voor het schroeven op metal stud of zachtere materialen.



DFR551RTJ



DFR550ZJ

Coming soon!

Coming soon!

**"Push Drive"-technologie:** de motor start automatisch wanneer de neus van de machine tegen de ondergrond wordt gedrukt.



	DFR550ZJ	DFR750Z	DFR453ZJ	DFR552ZJ	DFR452ZJ	DFR452RTJ	DFR551ZJ	DFR551RTJ
Spanning	18V	18V	18V	18V	18V	18V	18V	18V
Bijgeleverde accu's	0	0	0	0	0	2xBL1850B	0	2xBL1850B
Toerental	4000 t.p.m.	4000 t.p.m.	4500 t.p.m.	4500 t.p.m.	6000 t.p.m.	6000 t.p.m.	6000 t.p.m.	6000 t.p.m.
BL motor	-	-	✓	✓	✓	✓	✓	✓
Ø Gipsplaat Schroef	4,0 mm	4,0 mm	3,5-4,2 mm	3,5-4,2 mm	3,5-4,2 mm	3,5-4,2 mm	3,5-4,2 mm	3,5-4,2 mm
Schroeflengte	25-55 mm	45-75 mm	20-41 mm	20-55 mm	20-41 mm	20-41 mm	25-55 mm	25-55 mm
"Push drive" technologie	-	-	✓	✓	✓	✓	✓	✓
Gewicht	2,1 kg	2,1 kg	2,2 kg	2,2 kg	2,2 kg	2,2 kg	2,2 kg	2,2 kg
Prijs in €	excl. btw							
	incl. btw							

SCHROEVEN OP LINT



	F-30913	F-30926	F-31153	F-31166	F-30939	F-30942	F-30955	F-31179	F-31182	F-31140
Gebruik	Gipsplaat Schroeven op lint (fijne draad) voor gebruik op metal studs						Gipsplaat Schroeven op lint (groe draad) voor gebruik op hout			
Dikte (mm)	3,9	3,9	3,9	3,9	3,9	3,9	3,9	3,9	3,9	3,9
Lengte (mm)	25	30	35	41	45	55	30	35	41	55
Bitmaat	PH2	PH2	PH2	PH2	PH2	PH2	PH2	PH2	PH2	PH2
Afwerking	gefosfateerd	gefosfateerd	gefosfateerd	gefosfateerd	gefosfateerd	gefosfateerd	gefosfateerd	gefosfateerd	gefosfateerd	gefosfateerd
Schroeven per doos	1000	1000	1000	1000	1000	1000	1000	1000	1000	1000
Prijs in €	excl. btw									
	incl. btw									

ACCU SCHROEVENDRAAIERS

Duw-aandraaistand ("Push drive")



In de duw-aandraaistand gaan de motor en de schroefkop automatisch draaien wanneer er druk op wordt uitgeoefend.



DFS452FJX2

DFS250RTJ

	DFS250RTJ	DFS452RAJ	DFS452FJX2
Spanning	18V	18V	18V
Bijgeleverde accu's	2 x BL1850B	2 x BL1820B	2 x BL1830B
Toerental	0-2500 t.p.m.	0-4000 t.p.m.	0-4000 t.p.m.
Incl. schroeflintadapter	-	-	✓
Schroeflengte	-	-	25-55 mm
"Push drive" technologie	-	✓	✓
Gewicht	1,5 kg	1,5 kg	1,5 kg
Prijs in €	excl. btw		
	incl. btw		



Afzonderlijke aan/uit en vergrendelingsknop



**NIEUW**

**DRT52Z**

Spanning	18V
Bijgeleverde accu's	-
Max. induikdiepte	35 mm
Toerental onbelast	30000 min <sup>-1</sup>
Ø spantang - bereik	6 - 8 mm
Ø spantang - inbegrepen	6 mm
Gewicht	1,3 - 1,6 kg
Prijs in €	excl. btw
	incl. btw

## DRT52Z

- Budgetvriendelijk model met prestaties die een gesnoerd model evenaren
- Efficiënte BL motor
- Met aan/uit schakelaar en afzonderlijke knop voor het in-of uitschakelen van de standby-mode met led indicatie, dit voorkomt onbedoeld starten
- Geleverd met trimgeleider, parallel-/cirkelgeleider en kopieerring.



**DRT50ZJX3**

**DRT50RTJX3**

Spanning	18V	18V
Bijgeleverde accu's	0	2 x BL1850B
Max. induikdiepte	35 mm	35 mm
Toerental onbelast	10.000-30.000 t.p.m.	10.000-30.000 t.p.m.
Ø spantang - bereik	6 - 8 mm	6 - 8 mm
Ø spantang - inbegrepen	6 mm, 8 mm	6 mm, 8 mm
Gewicht	2,1 kg	2,1 kg
Prijs in €	excl. btw	
	incl. btw	

DTM51



DTM52



STARLOCK



Gereedschapsloze accessoirewissel

- Compatibel met OIS en Starlock (niet met Starlock Plus en Starlock Max).
- Inclusief: set van 9 accessoires, 30 schuurvellen, 1 afzuigset



incl. accessoires

- Compatibel met Starlock, Starlock Plus en Starlock Max accessoires, ideaal voor de zwaardere toepassingen.
- Grote oscillatiehoek van 1,8° links/rechts
- Zeer lage trillingswaarden dankzij AVT technologie
- Kleine greepomtrek en laag gewicht



Wist je dat er van DTM51 de voordelige uitvoeringen DTM51Z en DTM51TJX2 bestaan? Zie p. 68-69 voor meer info

STARLOCK STARLOCKPLUS STARLOCKMAX

	DTM51RTJX2	DTM52RTJX1
Spanning	18V	18V
Bijgeleverde accu's	2 x BL1850B	2 x BL1850B
BL motor	-	✓
Oscillatiefrequentie	6000-20000 /min	10000-20000 /min
Oscillatiehoek	3,2°	3,6°
Opname	OIS, Starlock	Starlock, Starlock Plus, Starlock Max
Gewicht	2,0 kg	1,7 kg
Prijs in €	excl. btw	
	incl. btw	

STARLOCK



STARLOCKPLUS



Starlock Plus en Starlock Max accessoires enkel voor DTM52.

STARLOCKMAX



Starlock Plus en Starlock Max accessoires enkel voor DTM52.

- ✓ Snelle wissel van accessoires door een simpele klik
- ✓ Starlock Plus zaagbladen: snel, diep en veelzijdig invallend zagen
- ✓ Starlock Max zaagbladen: zelfs voor de meest veeleisende en zware toepassingen

Scan hier voor het totaal overzicht van het assortiment





ACCU HANDPALMVLAKSCHUURMACHINES



DBO480: standaard met extra driehoekszool



		DBO480RTJ	DBO481RTJ	DBO482RTJ	DBO484ZJ
Spanning		18V	18V	18V	18V
Bijgeleverde accu's		2x BL1850B	2x BL1850B	2x BL1850B	-
Afmetingen schuurvoet		112 mm x 102 mm	112 mm x 102 mm	112 mm x 102 mm	112 mm x 102 mm
Papierbevestiging		Klem/Velcro	Klem	Klem	Klem/Velcro
Materiaal schuurvoet		Kunststof	Kunststof	Aluminium	Aluminium
Aantal schuurbewegingen		22000/28000 min <sup>-1</sup>	22000/28000 min <sup>-1</sup>	22000/28000 min <sup>-1</sup>	22000/28000 min <sup>-1</sup>
Schuuruitslag		1,5 mm	1,5 mm	1,5 mm	1,5 mm
AWS ready		-	-	✓	✓
Gewicht		1,4-1,8 kg	1,4-1,8 kg	1,4-1,8 kg	1,4-1,8 kg
Prijs in €	excl. btw				
	incl. btw				

ACCU VLAKSCHUURMACHINES



		DBO380RTJ	DBO381ZJU	DBO382ZJ
Spanning		18V	18V	18V
Bijgeleverde accu's		2x BL1850B	-	-
Afmetingen schuurvoet		92 mm x 185 mm	92 mm x 185 mm	92 mm x 185 mm
Papierbevestiging		Klem	Klem	Klem/velcro
Materiaal schuurvoet		Aluminium	Aluminium	Aluminium
Aantal schuurbewegingen		8000/16000/24000 min <sup>-1</sup>	8000/16000/24000 min <sup>-1</sup>	8000/16000/24000 min <sup>-1</sup>
Schuuruitslag		2,0 mm	2,0 mm	2,0 mm
AWS		-	✓	-
Gewicht		1,9 - 2,2 kg	1,9 - 2,2 kg	1,9 - 2,2 kg
Prijs in €	excl. btw			
	incl. btw			

ACCU EXCENTRISCHE POLIJSTMACHINE



Vrije rotatie en geforceerde rotatie

		DPO500Z	DPO600Z
Spanning		18V	18V
Bijgeleverde accu's		0	0
Oscillatiefrequentie		0-13600 min <sup>-1</sup>	0-13600 min <sup>-1</sup>
Schuurvoet		125 mm	150 mm
Schuuruitslag		5,5 mm	5,5 mm
Gewicht		3,1 kg	3,1 kg
Prijs in €	excl. btw		
	incl. btw		

ACCU BANDSCHUURMACHINE 9 MM



Richtbare led en zijhandgreep



Werkbereik 90° met uiterste stand 160° voor het opbergen.

Hoog gebruikscomfort en perfecte balans door centrale plaatsing van de motor



**DBS180RTJ**

Spanning	18 V
Bijgeleverde accu's	2 x BL1850B
Bandsnelheid	600 - 1700 m/min
Schuurband	9 x 533 mm
Gewicht	1,8 - 2,1 kg
Prijs in €	excl. btw
	incl. btw

ACCU EXCENTRISCHE SCHUURMACHINE 125 MM



**DBO180RTJ**

Spanning	18 V
Bijgeleverde accu's	2 x BL1850B
Diameter schuurvoet	125 mm
Aantal schuurbewegingen	14000 - 22000 mm <sup>-1</sup>
Schuuruitslag	2,8 mm
Gewicht	1,7 kg
Prijs in €	excl. btw
	incl. btw

ACCU SCHUURPOLIJSTMACHINE 75 MM



**Polijsten**  
Steunschijf met velcro opname voor polijst toepassingen.

**Compact**  
Uiterst compacte machine met de handgreep kort bij de schijf voor een optimale controle.

DPV300RTJ

- Zeer compacte machine ideaal voor het schuren en polijsten van kleine oppervlakken.
- Twee mechanische versnellingen en traploze snelheidsregeling.
- Geleverd met velcro steunschijf voor het polijsten en een Roloc™ opname voor schuurtoepassingen.



**Schuren**  
Roloc™ compatibele opname voor schuurtoepassingen.

● Accessoires

**Steunschijf**

Referentie	Omschrijving
E-07412	Schuurschijf aluminiumoxide 50 mm A60 (25 st.)
E-07428	Schuurschijf aluminiumoxide 50 mm A80 (25 st.)
E-07434	Schuurschijf aluminiumoxide 50 mm A120 (25 st.)
E-07440	Schuurschijf zirconium 50 mm Z60 (25 st.)
E-07456	Schuurschijf zirconium 50 mm Z80 (25 st.)
E-07462	Vliesschijf zirconium Grof / Hard 50 mm (25 st.)
E-07478	Vliesschijf zirconium Medium / Hard 50 mm (25 st.)
E-07484	Vliesschijf zirconium Fijn / Hard 50 mm (25 st.)
E-07490	Vliesschijf zirconium Medium/ Zacht 50 mm (25 st.)
E-07509	Vliesschijf zirconium Fijn/Zacht 50 mm (25 st.)
E-07515	Vliesschijf zirconium Zeer fijn/ Zacht 50 mm (25 st.)

Prijs excl. btw | Prijs incl. btw

**DPV300RTJ**

Bijgeleverde accu's	2 x BL1850
Capaciteit polijsten	80 mm
Capaciteit schuren	50 mm
Toerental polijsten	0-2800 min <sup>-1</sup>
Toerental schuren	0-9500 min <sup>-1</sup>
Gewicht	1,3 kg
Prijs in €	excl. btw
	incl. btw

ACCU BANDZAGEN



DPB180Z

Aluminium  
behuizing



DPB183Z



DPB184Z

	DPB180Z	DPB184Z	DPB183Z
Spanning	18 V	18 V	18 V
Bijgeleverde accu's	-	-	-
Bijgeleverde lader	-	-	-
Max. bandsnelheid	162 m/min	192 m/min	192 m/min
Capaciteit stalen buis	120 x 120 mm	51 x 51 mm	66 x 66 mm
BL-motor	-	✓	✓
Gewicht	6,8 kg	3,2 kg	3,8 kg
Prijs in €	excl. btw		
	incl. btw		

ACCU METAALAFKORTMACHINE



DLW140PG2

Gereedschapsloze  
(hoek)-verstelling van  
de geleider.

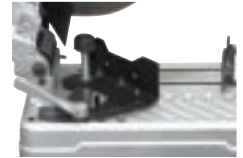

	DLW140Z	DLW140PG2
Spanning	2 x 18 V	2 x 18 V
Bijgeleverde accu's	0	2 x BL1860B
Toerental onbelast	3800 t.p.m.	3800 t.p.m.
Diameter schijf	355 mm	355 mm
Gewicht	16,9 kg	16,9 kg
Prijs in €	excl. btw	
	incl. btw	

ACCU BLINDKLINKNAGELPISTOLEN



DRV150Z



Scan deze code  
voor uitgebreide  
technische info.

	DRV150Z	DRV250Z
Bijgeleverde accu's/lader	-	-
Trekkracht	10 kN	20 kN
Compatibel met blindklinknagel Ø	24/32/40/48mm	48/60/64mm
Slaglengthe	25 mm	30 mm
Gewicht	1,9 kg	2,1 kg
Prijs in €	excl. btw	
	incl. btw	



ACCU AFKORTSLIJPMACHINES



DMC300RTJ

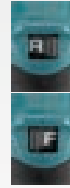

DMC300

- Zeer compacte slijpmachine, ideaal voor het zagen op moeilijk bereikbare plaatsen
- Goed uitgebalanceerd, kan veilig met één hand gebruikt worden
- De draairichting is omkeerbaar
- Stofkap met aansluiting voor stofafzuiging standaard bijgeleverd
- Voor het zagen in staal, keramiek en kunststoffen



D-74815-5 D-77263 D-74837

Accessoires

Ref	Type	Prijs excl. btw	Prijs incl. btw
D-74815-5	Doorslijpschijf voor RVS 76mm (5 stuks)		
D-77263	Diamantschijf 76x1,4x10mm		
D-74837	Carbide multi-snijschijf 76x10mm		

	DMC300ZJ	DMC300RTJ
Spanning	18 V	18 V
Bijgeleverde accu's	-	2x BL1850B
Lader	-	DC18RC
Ø schijf	76 mm	76 mm
Toerental onbelast	20000 min <sup>-1</sup>	20000 min <sup>-1</sup>
Max. zaagdiepte	met stofkap: 13,5 mm zonder stofkap: 16,0 mm	met stofkap: 13,5 mm zonder stofkap: 16,0 mm
Gewicht	1,2 - 1,7 kg	1,2 - 1,7 kg
Prijs in €	excl. btw	
	incl. btw	

ACCU DOORSLIJPER



DCE090T2X1

Maximale zaagdiepte 88 mm

Promo gratis 25 doorslijpschijven RVS

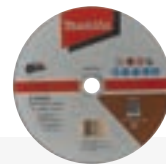

Accessoires

Ref	Type	Prijs excl. btw	Prijs incl. btw
E-03006-25	Doorslijpschijf RVS (25 st.) 230 x 2,0 x 22,23 mm		
E-02967	Diamantschijf 230 mm x 2,4 x 22,23 mm		

De gesegmenteerde diamantschijf E-02967 werd speciaal ontwikkeld voor het gebruik met een accu doorslijper. De diamantkorrels zijn gelijkmatig verdeeld en volgens een speciaal V-vormig patroon ingebed. Daardoor blijft de schijf continu scherp en zijn de zaagprestaties optimaal.



	DCE090ZX1
Spanning	2 x 18 V
Bijgeleverde accu's	0
Lader	-
Ø schijf	230 mm
Toerental onbelast	6600 min <sup>-1</sup>
Max. zaagdiepte	88 mm
Max. schijfdikte	3,0 mm
Gewicht	5,6 - 6,3 kg
Prijs in €	excl. btw
	incl. btw

ACCU DIAMANTZAAG 125 MM



Inclusief 2 stofkappen, voor droog en nat gebruik

Ideaal voor afwerking (steen, beton, keramiek)

Kantelbaar tot 45°

	DCC501RTJ
Spanning	18 V
Toerental onbelast	8500 min <sup>-1</sup>
AWS	✓ excl. Bluetooth unit
Diameter asgat	20 mm
Bijgeleverde accu's	2 x BL1850B
Gewicht	2,7 kg
Prijs in €	excl. btw
	incl. btw

ACCU HAAKSE SLIJERS 125 MM

**ADT AFT** **BL MOTOR**

Wist je dat er van DGA506 en DGA508 de voordelige uitvoeringen DGA506Z / DGA506T1J en DGA508Z / DGA508T1J bestaan? Zie p. 68-69 voor meer info!

Promo DGA506T1J en DGA508T1J: gratis 10 doorslijpschijven D-18770-10 zie p. 69



DGA506RTJ

DGA518RTJU

Promo DGA506RTJ en DGA508RTJ: gratis extra accu BL1850B

	DGA506RTJ	DGA508RTJ	DGA513RTJ	DGA514RTJU	DGA517RTJ	DGA518RTJU
Spanning	18V	18V	18V	18V	18V	18V
Bijgeleverde accu's	2 x BL1850B	2 x BL1850B	2 x BL1850B	2 x BL1850B	2 x BL1850B	2 x BL1850B
Ø schijf	125 mm	125 mm	125 mm	125 mm	125 mm	125 mm
Heropstartbeveiliging	✓	✓	✓	✓	✓	✓
Elektrische rem	✓	✓	✓	✓	✓	✓
Regelbaar toerental	-	-	✓	✓	✓	✓
AWS	-	-	-	✓	-	✓
Schakelaar	Schuifschakelaar met vergrendeling	Lepeschakelaar, zonder vergrendeling	Schuifschakelaar met vergrendeling	Schuifschakelaar met vergrendeling	Lepeschakelaar, zonder vergrendeling	Lepeschakelaar, zonder vergrendeling
Gewicht	2,5 kg	2,5 kg	2,5 kg	2,5 kg	2,5 kg	2,5 kg
Prijs in €	excl. btw					
	incl. btw					

BESCHERMKAP MET STOFAFZUIGING VOOR HAAKSE SLIJERS



	196845-3	198440-5
Diameter stofkap	125 mm	230 mm
Max. zaagdiepte	20 mm	60 mm
Prijs in €	excl. btw	
	incl. btw	

ACCU STEPELSLIJPER



DGD800RTJ

Spanning	18V
Bijgeleverde accu's	2 x BL1850B
Toerental	25000 t.p.m.
Ø spantang - bereik	6 - 8 mm
Ø spantang - inbegrepen	6 mm
Gewicht	2,1 kg
Prijs in €	excl. btw
	incl. btw

ACCU HAAKSE SLIJERS 180-230 MM

**ADT AFT** **18V + 18V** **36V**



DGA701ZKU

	DGA701ZKU	DGA900ZK	DGA901PGZU
Spanning	2 x 18V	2 x 18V	2 x 18V
Bijgeleverde accu's	0	0	2 x BL1860B
Ø schijf	180 mm	230 mm	230 mm
AWS	✓	-	✓
Gewicht	5,0 kg	5,2 kg	5,2 kg
Prijs in €	excl. btw		
	incl. btw		

ACCU HAAKSE SLIJPER 125 MM X-LOCK



DGA519RTJ



DGA521ZX1



	DGA521ZX1	DGA520ZX1	DGA519ZJ	DGA519RTJ
Spanning	18 V	18 V	18 V	18 V
Bijgeleverde accu's	0	0	0	2 x BL1850B
Ø schijf	125 mm	125 mm	125 mm	125 mm
Toerental onbelast	8500 min <sup>-1</sup>	8500 min <sup>-1</sup>	3000 - 8500 t.p.m.	3000 - 8500 t.p.m.
Heropstartbeveiliging	✓	✓	✓	✓
Elektrische rem	-	✓	✓	✓
Regelbaar toerental	-	-	✓	✓
Type schakelaar	Schuifschakelaar met vergrendeling	Lepelschakelaar zonder vergrendeling	Lepelschakelaar zonder vergrendeling	Lepelschakelaar zonder vergrendeling
Gewicht	2,4 - 3,0 kg	2,4 - 3,0 kg	2,5 kg	2,5 kg
Prijs in €	excl. btw			
	incl. btw			



Snel en veilig schijven bevestigen via een kliksysteem.



ACCESSOIRES X-LOCK

Referentie	Type	Prijs excl. btw	Prijs incl. btw
E-00393	Afbraamschijf voor metaal 125 mm x 6 x 22,23		
E-00402	Afbraamschijf voor inox 125 mm x 6 x 22,23		
E-00418	Doorslijpschijf voor inox 125 mm x 1,2 x 22,23		
E-02076	Diamantdoorslijpschijf 125 mm		
191G05-4	Beschermkap met stofafzuiging 125 mm		
D-73396	Komborstel voor metaal, gegolfde draad 75 mm x 0,3		
D-73433	Komborstel voor metaal, gegolfde draad, vermessingd 75 mm x 0,3		
D-73346	Komborstel voor inox, gegolfde draad 75 mm x 0,3		
D-73374	Komborstel voor metaal, getordeerde draad 80 mm x 0,35		
D-73380	Komborstel voor metaal, getordeerde draad 80 mm x 0,5		
D-73330	Komborstel voor inox, getordeerde draad 80 mm x 0,5		
D-73449	Kegelborstel voor metaal, gegolfde draad 100 mm x 0,3		
D-73411	Schijfborstel voor metaal, getordeerde draad 115 mm x 0,5		
D-73427	Schijfborstel voor metaal, gegolfde draad 115 mm x 0,3		
E-11776	Doorslijpschijf TCG 125 mm x 2 x 22,23 X-Lock		
E-19738	Vacuum gesoldeerde diamantschijf 125 mm		





ACCU PLAATSCHAREN



DJS130ZJ



DJS800Z



DJS131Z



DJS200Z



**DJS800**

- Geschikt voor het knippen van o.a. cementbeplating, brandwerende platen en geluidsisolatieplaten tot 13 mm dikte.
- Knipt vrijwel stofvrij, snel en zonder lawaai.
- De snijkop is 360° draaibaar voor knippen op moeilijk bereikbare plaatsen.

bij alle modellen kan de kop 360° gedraaid worden

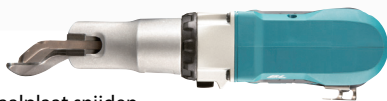

**DJS131**

- Kan bochten en gegolfde staalplaat snijden

**DJS130/DJS200**

- Voor het knippen van rechte stukken met minimale vervorming

	DJS130ZJ	DJS200Z	DJS131Z	DJS800Z
Spanning	18V	18V	18V	18V
Bijgeleverde accu's	-	-	-	-
BL-motor	-	✓	✓	✓
Aantal zaagbewegingen	2800 min <sup>-1</sup>	0-3000 min <sup>-1</sup>	0-3000 min <sup>-1</sup>	0-3000 min <sup>-1</sup>
Max. dikte staal	1,3 mm	2,0 mm	1,3 mm	13 mm (vezelcement)
Gewicht	2,3 - 2,6 kg	2,2 - 2,5 kg	2,0 - 2,3 kg	2,1 - 2,5 kg
Prijs in €	excl. btw			
	incl. btw			

ACCU KNABELSCHAAR



DJN161RTJ

Spanning	18V
Bijgeleverde accu's	2 x BL1850B
Max. aantal snijbewegingen	1900 min <sup>-1</sup>
Max. dikte staal	1,6 mm
Gewicht	2,2 kg
Prijs in €	excl. btw
	incl. btw



ACCU VLECHTMACHINE



DTR180ZJ



Promo DTR180ZJ :  
gratis doos  
gegalvaniseerde  
binddraad 191A57-9



DTR181ZJ

**DTR181**

- Deze versie kan grotere verbindingen maken, tot bijvoorbeeld: (2 x 16 mm) + (2 x 13 mm) of 25 mm + 22 mm.

Optioneel accessoire:  
handgreep 191M27-0



		DTR180ZJ	DTR181ZJ
Spanning		18 V / 14,4 V	18 V / 14,4 V
Bijgeleverde accu's		0	0
Vlechtcapaciteit		10 mm + 10 mm (2 x 13 mm) + (2 x 13 mm)	16 mm + 16 mm (2 x 16 mm) + (2 x 13 mm)
Draaddikte		0,8 mm	0,8 mm
Modus		Enkelvoudig/continu	Enkelvoudig/continu
Gewicht		2,3 kg	2,3 kg
Prijs in €	excl. btw		
	incl. btw		



Polyester draad: 191J59-9  
(100 m, Ø 0,8 mm) 50 stuks/doos



Vlechtdraad gegalvaniseerd: 191A57-9  
(100 m, Ø 0,8 mm) 50 stuks/doos



Vlechtdraad staal: 199137-9  
(100 m, Ø 0,8 mm) 50 stuks/doos

ACCU VACUÛMPOMP



**DVP181**

- Kan continu werken dankzij twee accu's in parallel
- Tweetraps pomp met hoog debiet



DVP181ZK



DVP180Z

		DVP180Z	DVP181ZK
Spanning		18 V	18 V, 2 accu's in parallel
Bijgeleverde accu/lader		-	-
Compressor		ééntraps olieafgedichte schottenpomp	Tweetraps olieafgedichte schottenpomp
Debiet		60 l/min	113 l/min
Eindvacuüm		20 Pa (150 micron)	3 Pa (22,5 micron)
Gewicht		2,9 kg	8,2 kg
Prijs in €	excl. btw		
	incl. btw		

ACCU KITPISTOOL



INCLUSIEF  
kokerhouder  
600 ml bij  
DCG180RAX



600 ml



DCG180RAX



DCG180RA  
300 ml

		DCG180RA	DCG180RAX
Spanning		18 V	18 V
Bijgeleverde accu's		1 x BL1820B	1 x BL1820B
Max. spuitdruk		5000 N	5000 N
Max. extrusiesnelheid		0-28 mm/s	0-28 mm/s
Gewicht		2,1 kg	2,4 kg
Prijs in €	excl. btw		
	incl. btw		

## DTC100 - DTC101 - DTC102 - DTC103

- Voor het knippen van zware elektriciteitskabels on site
- Lichtgewicht ontwerp en uitstekende manoeuvreerbaarheid
- Gesloten en open types
- Voor het knippen van aluminium/koperkabel (DTC100, DTC101, DTC102) en staalversterkte aluminium kabel (ASCR) (DTC103)
- Automatisch terugkeer van het mes na het snijden



Verstelbare  
openingshoek  
van de schaar



DTC100ZK



DTC101ZK



DTC102ZK

Leverbaar vanaf november 2024



DTC103ZK

Leverbaar vanaf november 2024

**NIEUW**

**DTC100ZK**

**NIEUW**

**DTC101ZK**

**NIEUW**

**DTC102ZK**

**NIEUW**

**DTC103ZK**

	DTC100ZK	DTC101ZK	DTC102ZK	DTC103ZK
Spanning	18V	18V	18V	18V
Toepassing	Aluminium/koper kabel	Aluminium/koper kabel	Aluminium/koper kabel	ACSR
Type	Gesloten	Open	Gesloten	Gesloten
Maximale opening	50 mm	50 mm	65 mm	54 mm
Knipcapaciteit*	35 - 47 mm	35 - 47 mm	65 mm max.	54 mm max.
Gewicht	2,9 kg	3,6 kg	3,5 kg	5,5 kg
Prijs in €	excl. btw			
	incl. btw			

\*De exacte knipcapaciteit is afhankelijk van het type kabel: het aantal geleiders, de uitvoering (gevlochten of massief) en de dikte van de ommanteling.





ACCU DRAADSTANGKNIPPERS



Voor gebruiksklaar afkorten zonder vonken



DSC102

Mobiel afkorten

DSC102ZJ



DSC121ZK

Stationair afkorten

	DSC102ZJ	DSC121ZK
Spanning	18 V	18 V
Bijgeleverde accu's	0	0
Snijcapaciteit	M6/M8/M10	M8/M10/M12
Inbegrepen messenset	M8/M10	M8
Gewicht	3,3 kg	5,7 kg
Prijs in €	excl. btw	
	incl. btw	

ACCU BETONIJSERZAAG



DSC251ZK

Spanning	18 V
Bijgeleverde accu's/lader	0
Snijcapaciteit	10-25 mm
Gewicht	3,9 kg
Prijs in €	excl. btw
	incl. btw

ACCU HYDRAULISCHE BETONIJSERKNIPPERS



DSC163ZK

DSC163ZK DSC191Z

Spanning	18 V	18 V
Bijgeleverde accu's/lader	-	-
Snijcapaciteit	3 - 16 mm	3 - 20 mm
BL-motor	✓	-
Gewicht	6,9 kg	11,1 - 11,2 kg
Prijs in €	excl. btw	
	incl. btw	

ACCU PONSMACHINE



DPP200ZK

Spanning	18 V
Max. diameter ponsgat	20 mm
Inbegrepen Ø	12 mm
Max. dikte staal	8 mm
Max. dikte inox	6 mm
Gewicht	10,5 kg
Prijs in €	excl. btw
	incl. btw

ACCU VETPOMP



Werkt met standaard 400 g patronen of vet in bulk



Debietregeling: automatisch of traag (met hoogste druk)



DGP180RT

Hogedrukslang van 120 cm



	DGP180Z	DGP180RT
Spanning	18V	18V
Bijgeleverde accu's	-	1 x BL1850B
Maximale druk	690 bar	690 bar
Debiet	145-290 ml/min	145-290 ml/min
Gewicht	4,8 kg	4,8 kg
Prijs in €	excl. btw	
	incl. btw	

ACCU BETONTRILNAALDEN



DVR850Z

	DVR350Z	DVR450Z	DVR850Z
Spanning	18V	18V	18V
Bijgeleverde accu's	0	0	0
Lengte trilnaald	80 cm	120 cm	240 cm
Diameter trilnaald	25 mm	25 mm	25 mm
Gewicht	2,0 kg	2,3 kg	2,4 kg
Prijs in €	excl. btw		
	incl. btw		

BETONTRILNAALDEN MET DIRECTE AANSLUITING OP HET ACCUPACK



- Voeding middels PDC draagbaar accupack (accupack niet inbegrepen)
- Zeer comfortabel werken omdat enkel de trilnaald gehanteerd moet worden.
- Compatibel met flessen met grote diameter Ø 43 mm en Ø 52 mm
- Werktijd tot 300 minuten met PDC1200



VR004C

































VR001C



	VR001CZ	VR002CZ	VR003CZ	VR004CZ
Spanning	36V (Direct connect)	36V (Direct connect)	36V (Direct connect)	36V (Direct connect)
Bijgeleverde accu's	-	-	-	-
Trilfrequentie	1200 min <sup>-1</sup>	1200 min <sup>-1</sup>	1200 min <sup>-1</sup>	1200 min <sup>-1</sup>
Ø trifles	43 mm	43 mm	52 mm	52 mm
Lengte trilnaald	1,5 m	3,0 m	1,5 m	3,0 m
Autonomie (PDC1200)	300 min	300 min	200 min	200 min
Gewicht	11,8 kg	12,9 kg	12,6 kg	13,7 kg
Prijs in €	excl. btw			
	incl. btw			

# BESPAAR MET ONZE COMBOPACKS

MACHINES IN COMBOPACK 18 V		ACCU	DC18RC	MAK-PAC	PRIJS IN €
 DHP485	 DTD156	2 x  BL1830B			<b>DLX2394J</b> <b>NIEUW</b>
 DDF485	 DTD153	3 x  BL1850B			<b>DLX2289T3J</b>
 DDF484	 DTD153	3 x  BL1850B			<b>DLX2189T3J</b>
 DDF489	 DHR243	2 x  BL1850B			<b>DLX2522TJ</b>
 DTD153	 DTD153	3 x  BL1850B			<b>DLX2236TJ1</b>
 DGA506	 DHP486	3 x  BL1850B			<b>DLX2434TJ</b>







# BESPAAR MET ONZE COMBOPACKS

	DHP486	DHP489	DTD153	DHR243	DGA506	DHS680	DJV181	DTM51
DLX2507T3J <b>NIEUW</b>								
DLX4183T3J <b>NIEUW</b>								
DLX5093TJ								
DLX5071TJ								
DLX7030T3J <b>NIEUW</b>								
DLX1055JX1								
DLX1122JX1								

## PROMO batterij BL1850B meteen geleverd in Makpac

Combineer  
voordelig met deze  
aanbieding

Deze modellen bestaan  
ook in een voordelige  
'Z-versie' zonder accu,  
lader, Makpac of andere  
extra toebehoren.





# TR00000001 TROLLEY



DJR188Z	DRT50JX3	DBO180ZJ	DDA351ZJ	BL1850B 18 V 5,0 Ah	DC18RC	KOFFER	PRIJS IN €
				3 x			
				3 x		2 x	
				3 x		3 x	
				3 x		3 x	
				3 x		4 x	
				5 x	2 x	9 x	
				5 x	2 x	10 x	



DHS680T1J



DTW300T1J



DJV181T1J



DJV182T1J



Extra promo  
DGA506T1J &  
DGA508T1J: Gratis  
10 doorslijpschijven  
D-18770-10

DGA506T1J



DGA508T1J



**DBN500ZJ**Minibrad-  
pistool 18 V

Prijs excl. BTW Prijs incl. BTW



Makpac

**HET LXT -PLATFORM****DBN600ZJ**Bradpistool  
18 V

Prijs excl. BTW Prijs incl. BTW



Makpac

**DBO180ZJ**Excentrische  
schuurmachine 18 V

Prijs excl. BTW



Prijs incl. BTW

Makpac

**DBO380ZJ**Vlakschuur-  
machine 18 V

Prijs excl. BTW



Prijs incl. BTW

Makpac

**DBO381ZJU**Vlakschuur-  
machine 18 V

Prijs excl. BTW



Prijs incl. BTW

Makpac

**DBO480ZJ**Vlakschuurmachine  
18 V

Prijs excl. BTW



Prijs incl. BTW

Makpac

**DBO481ZJ**Vlakschuurmachine  
18 V

Prijs excl. BTW



Prijs incl. BTW

Makpac

**DBO482ZJ**Vlakschuurmachine  
18 V

Prijs excl. BTW



Prijs incl. BTW

Makpac

**DBS180ZJ**Bandschuurmachine  
9 mm 18 V

Prijs excl. BTW



Prijs incl. BTW

Makpac

**DCB200B**

Verwarmd deken 18 V

Prijs excl. BTW



Prijs incl. BTW

Karton

**DCC501ZJ**Diamantzaag  
125 mm 18 V

Prijs excl. BTW



Prijs incl. BTW

Makpac

**DCG180ZK**

Kitpistool 18 V

Prijs excl. BTW



Prijs incl. BTW

Koffer

**DCG180ZXK**Kitpistool 18 V incl.  
kokerhouder

Prijs excl. BTW



Prijs incl. BTW

Koffer

**DCO181Z**Gipsfrees  
18 V

Prijs excl. BTW



Prijs incl. BTW

Karton

**DCS552ZJ**Metaalcirkelzaag  
18 V

Prijs excl. BTW



Prijs incl. BTW

Makpac

**DCS553ZJ**Metaalcirkelzaag  
18 V

Prijs excl. BTW

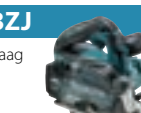

Prijs incl. BTW

Makpac

**DDA351ZJ**Haakse boor-  
machine 18 V

Prijs excl. BTW



Prijs incl. BTW

Makpac

**DDA450ZK**Haakse  
boormachine 18 V

Prijs excl. BTW



Prijs incl. BTW

Koffer

**DDF083ZJ**Boor- en schroef-  
machine 1/4" 18 V

Prijs excl. BTW



Prijs incl. BTW

Makpac

**DDF482ZJ**Boor- en schroef-  
machine 18 V

Prijs excl. BTW



Prijs incl. BTW

Makpac

**DDF484Z**Boor- en schroef-  
machine 18 V

Prijs excl. BTW



Prijs incl. BTW

Karton

**DDF489ZJ**Boor- en schroef-  
machine 18 V

Prijs excl. BTW



Prijs incl. BTW

Makpac

**DDF486ZJ**Boor- en schroef-  
machine 18 V

Prijs excl. BTW



Prijs incl. BTW

Makpac

**DFN350ZJ**Minibradpistool  
18 V

Prijs excl. BTW



Prijs incl. BTW

Makpac

**DFR452ZJ**Schroef-  
automaat 18 V

Prijs excl. BTW



Prijs incl. BTW

Makpac

**DFR550ZJ**Schroef-  
automaat 18 V

Prijs excl. BTW



Prijs incl. BTW

Makpac

**DFR551ZJ**Schroefautomaat  
18 V

Prijs excl. BTW



Prijs incl. BTW

Makpac

**DFR750Z**Schroef-  
automaat 18 V

Prijs excl. BTW



Prijs incl. BTW

Karton

**DFS250ZJ**Schroefmachine  
18 V

Prijs excl. BTW



Prijs incl. BTW

Makpac

**DFS452ZJ**Schroefmachine  
18 V

Prijs excl. BTW



Prijs incl. BTW

Makpac

**DGA506Z**Haakse slijper  
125 mm 18 V

Prijs excl. BTW



Prijs incl. BTW

Karton

**DGA508Z**Haakse slijper  
125 mm 18 V

Prijs excl. BTW



Prijs incl. BTW

Karton

**DGA513ZJ**Haakse slijper  
125 mm 18 V

Prijs excl. BTW



Prijs incl. BTW

Makpac

**DGA514ZJU**Haakse slijper  
125 mm 18 V

Prijs excl. BTW



Prijs incl. BTW

Makpac

**DGA517ZJ**Haakse slijper  
125 mm 18 V

Prijs excl. BTW



Prijs incl. BTW

Makpac

**DFR552ZJ**Schroefautomaat  
18 V

Prijs excl. BTW



Prijs incl. BTW

Makpac

**DFR453ZJ**Schroefautomaat  
18 V

Prijs excl. BTW



Prijs incl. BTW

Makpac

**NIEUW****DGA520ZX1**Haakse slijper  
125 mm X-lock 18 V

Prijs excl. BTW



Prijs incl. BTW

Karton

**DGA521ZX1**Haakse slijper  
125 mm X-lock 18 V

Prijs excl. BTW



Prijs incl. BTW

Karton

**DGD800ZJ**

Stempelslijper 18 V

Prijs excl. BTW



Prijs incl. BTW

Makpac

**DGP180Z**

Vetpomp 18 V

Prijs excl. BTW



Prijs incl. BTW

Karton

**DHG180ZJ**Hetelucht pistool  
18 V

Prijs excl. BTW



Prijs incl. BTW

Makpac

**DHG181ZJ**Hetelucht pistool  
18 V

Prijs excl. BTW



Prijs incl. BTW

Makpac

**DHP484ZJ**Klopboor- en  
schroefmachine 18 V

Prijs excl. BTW



Prijs incl. BTW

Makpac

**DHP489ZJ**Klopboor- en  
schroefmachine 18 V

Prijs excl. BTW



Prijs incl. BTW

Makpac

**DHP486Z**Klopboor- en  
schroefmachine 18 V

Prijs excl. BTW



Prijs incl. BTW

Karton

**DHR171ZJ**SDS-PLUS  
Boorhamer 18 V

Prijs excl. BTW



Prijs incl. BTW

Makpac

**DHR182ZJ**SDS-PLUS  
Boorhamer 18 V

Prijs excl. BTW



Prijs incl. BTW

Makpac

**DHR182ZWJ**SDS-PLUS  
Boorhamer 18 V

Prijs excl. BTW



Prijs incl. BTW

Makpac

**DHR183ZJ**SDS-PLUS  
Boorhamer 18 V

Prijs excl. BTW



Prijs incl. BTW

Makpac

**DHR202ZJ**SDS-PLUS  
Boorhamer 18 V

Prijs excl. BTW



Prijs incl. BTW

Makpac

**DHR243Z**SDS-PLUS  
Boorhamer 18 V

Prijs excl. BTW



Prijs incl. BTW

Karton



**DHR243ZJW**

SDS-PLUS Boorhamer 18 V + DX07  
Prijs excl. BTW



Prijs incl. BTW

Makpac

**DHR264ZJ**

Combihamer SDS+ 2 x 18 V  
Prijs excl. BTW



Prijs incl. BTW

Makpac

**DHS630ZJ**

Cirkelzaag 165 mm 18 V  
Prijs excl. BTW



Prijs incl. BTW

Makpac

**DHS660ZJ**

Cirkelzaag 165 mm 18 V  
Prijs excl. BTW



Prijs incl. BTW

Makpac

**DHS661ZJU**

Cirkelzaag 165 mm 18 V  
Prijs excl. BTW



Prijs incl. BTW

Makpac

**DHS680Z**

Cirkelzaag 165 mm 18 V  
Prijs excl. BTW



Prijs incl. BTW

Karton

**DHS710ZJ**

Cirkelzaag 190 mm 2 x 18 V  
Prijs excl. BTW



Prijs incl. BTW

Makpac

**DHS782ZJ**

Cirkelzaag 190 mm 2 x 18 V  
Prijs excl. BTW



Prijs incl. BTW

Makpac

**DHS783ZJU**

Cirkelzaag 190 mm 2 x 18 V  
Prijs excl. BTW



Prijs incl. BTW

Makpac

**DHS900Z**

Cirkelzaag 235 mm 2 x 18 V  
Prijs excl. BTW



Prijs incl. BTW

Karton

**DHS900ZU**

Cirkelzaag 235 mm 2 x 18 V  
Prijs excl. BTW



Prijs incl. BTW

Karton

**DJN161ZJ**

Knabberschaar 18 V  
Prijs excl. BTW



Prijs incl. BTW

Makpac

**DJR183ZJ**

Reciprozaag 18 V  
Prijs excl. BTW



Prijs incl. BTW

Makpac

**DJR186ZK**

Reciprozaag 18 V  
Prijs excl. BTW



Prijs incl. BTW

Koffer

**DJR187ZK**

Reciprozaag 18 V  
Prijs excl. BTW



Prijs incl. BTW

Koffer

**DJR188ZJ**

Reciprozaag 18 V  
Prijs excl. BTW



Prijs incl. BTW

Makpac

**DJR189ZJ**

Reciprozaag 18 V  
Prijs excl. BTW



Prijs incl. BTW

Makpac

**DJR360ZK**

Reciprozaag 2 x 18 V  
Prijs excl. BTW



Prijs incl. BTW

Koffer

**DCV202ZL**

Bodywarmer 18 V (maat: L)  
Prijs excl. BTW



Prijs incl. BTW

Makpac

**DCJ205ZL**

Verwarmde jas 18 V (maat: L)  
Prijs excl. BTW



Prijs incl. BTW

Karton

**DCJ206ZXL**

Verwarmde jas 18 V (maat: XL)  
Prijs excl. BTW



Prijs incl. BTW

Karton

**DJV181Z**

Decoupeerzaag 18 V  
Prijs excl. BTW



Prijs incl. BTW

Karton

**DJV182Z**

Decoupeerzaag 18 V  
Prijs excl. BTW



Prijs incl. BTW

Karton

**DJV184Z**

Decoupeerzaag 18 V  
Prijs excl. BTW



Prijs incl. BTW

Karton

**DJV185Z**

Decoupeerzaag 18 V  
Prijs excl. BTW



Prijs incl. BTW

Karton

**DKP181ZU**

Schaaf 18 V  
Prijs excl. BTW



Prijs incl. BTW

Karton

**DLS600Z**

Afkort-verstekzaag 165 mm 18 V  
Prijs excl. BTW



Prijs incl. BTW

Karton

**DPJ180ZJ**

Lamellenfrees 18 V  
Prijs excl. BTW



Prijs incl. BTW

Makpac

**DPT353ZJ**

Pinpistool 18 V  
Prijs excl. BTW



Prijs incl. BTW

Makpac

**DPV300ZJ**

Schuur- en polijst-  
machine 75 mm 18 V  
Prijs excl. BTW



Prijs incl. BTW

Makpac

**DRT50ZJ**

Boven- en kantenfrees 18 V  
Prijs excl. BTW



Prijs incl. BTW

Makpac

**DRV150ZJ**

Blindklinknagel-  
pistool 18 V  
Prijs excl. BTW



Prijs incl. BTW

Makpac

**DRV250ZJ**

Blindklinknagel-  
pistool 18 V  
Prijs excl. BTW



Prijs incl. BTW

Makpac

**DSD180ZJ**

Gipszaag 18 V  
Prijs excl. BTW



Prijs incl. BTW

Makpac

**DSP600ZJ**

Invalcirkelzaag 165 mm 2 x 18 V  
Prijs excl. BTW



Prijs incl. BTW

Makpac

**DSS501ZJ**

Cirkelzaag 136 mm 18 V  
Prijs excl. BTW



Prijs incl. BTW

Makpac

**DST112ZJ**

Nietmachine 18 V  
Prijs excl. BTW



Prijs incl. BTW

Makpac

**DST221ZJ**

Nietmachine 18 V  
Prijs excl. BTW



Prijs incl. BTW

Makpac

**DTD153Z**

Slagschroeven-  
draaier 18 V  
Prijs excl. BTW



Prijs incl. BTW

Karton

**DTD154ZJ**

Slagschroeven-  
draaier 18 V  
Prijs excl. BTW



Prijs incl. BTW

Makpac

**DTD156Z**

Slagschroeven-  
draaier 18 V  
Prijs excl. BTW



Prijs incl. BTW

Karton

**DTD157ZJ**

Slagschroeven-  
draaier 18 V  
Prijs excl. BTW



Prijs incl. BTW

Makpac

**DTD172ZJ**

Slagschroeven-  
draaier 18 V  
Prijs excl. BTW



Prijs incl. BTW

Makpac

**DTL061ZJ**

Haakse  
slagschroevendraaier 18 V  
Prijs excl. BTW



Prijs incl. BTW

Makpac

**DTM51Z**

Multitool 18 V  
Prijs excl. BTW



Prijs incl. BTW

Karton

**DTM52ZJ**

Multitool 18 V  
Prijs excl. BTW



Prijs incl. BTW

Makpac

**DTW1001ZJ**

Slagmoersleutel 18 V  
Prijs excl. BTW



Prijs incl. BTW

Makpac

**DTW1002ZJ**

Slagmoersleutel 18 V  
Prijs excl. BTW



Prijs incl. BTW

Makpac

**DTW180ZJ**

Slagmoersleutel 18 V  
Prijs excl. BTW



Prijs incl. BTW

Makpac

**DTW181ZJ**

Slagmoersleutel 18 V  
Prijs excl. BTW



Prijs incl. BTW

Makpac

**DTW190ZJ**

Slagmoersleutel 18 V  
Prijs excl. BTW



Prijs incl. BTW

Makpac

**DTW300Z**

Slagmoersleutel 18 V  
Prijs excl. BTW



Prijs incl. BTW

Karton

**DTW700ZJ**

Slagmoersleutel 18 V  
Prijs excl. BTW



Prijs incl. BTW

Makpac

**DUT130Z**

Menger 18 V  
Prijs excl. BTW



Prijs incl. BTW

Karton

**DWT310ZK**

Breekmoersleutel 2 x 18 V  
Prijs excl. BTW



Prijs incl. BTW

Koffer



Prijzen geldig t.e.m. 31/12/2024

ACCU BL1021B  
12Vmax 2,0 Ah



**197396-9**  
excl. btw  
incl. btw

ACCU BL1041B  
12Vmax 4,0 Ah



**197406-2**  
excl. btw  
incl. btw

OPLADER DC10SB

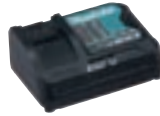

**197363-4**  
excl. btw  
incl. btw

OPLADER DC18RE



**LXT CXT**  
**198720-9**  
excl. btw  
incl. btw

BL1050B LI-ION ACCU 5,0  
AH 12VMAX



**1913G0-9**  
excl. btw  
incl. btw

## Krachtig Compact Lichtgewicht

POWERPACK 12Vmax  
2 x 2,0 Ah



**197658-5**  
excl. btw  
incl. btw

POWERPACK 12Vmax  
2 x 4,0 Ah



**197641-2**  
excl. btw  
incl. btw

POWERPACK LXT + CXT



**199026-8**  
excl. btw  
incl. btw

POWERPACK LXT + CXT



**199029-2**  
excl. btw  
incl. btw

### COMBOPACK CXT



CLX228SAX2



CLX206SAX3



CLX400SAJ1

**PROMO**

gratis lamp  
DEAML103 bij  
CLX228SAX2



CLX228SAX2 CLX206SAX3 CLX400SAJ1

	CLX228SAX2	CLX206SAX3	CLX400SAJ1
Spanning	10,8V	10,8V	10,8V
Bijgeleverde accu's	3x BL1021B	2x BL1020B	3x BL1020B
Lader	DC10SB	DC10SA	DC10SA
Samenstelling	HP333D TD110D	TM30D DF331D	DF331D TD110D HS301D JR103D
Makpac	-	-	1
Prijs in €	excl. btw		
	incl. btw		

ACCU BOOR- EN SCHROEFMACHINES

1/4" BITOPNAME



DF032DSAJ



DF033DWAJ

DF033DWAJ DF033DWMJ DF032DSAJ DF032DSMJ

Spanning	10,8 V	10,8 V	10,8 V	10,8 V
Bijgeleverde accu's	2 x BL1021B	2 x BL1040B	2 x BL1020B	2 x BL1040B
Hard koppel	30 Nm	30 Nm	35 Nm	35 Nm
BL-motor	-	-	✓	✓
Gewicht	0,9 kg	0,9 kg	0,9 kg	0,9 kg
Prijs in €	excl. btw			
	incl. btw			

ACCU BOOR- EN SCHROEFMACHINES



DF331DSMJ



DF333DNX10

DF333DNX10

Accu boor- & schroefmachine	DF333
Bijgeleverde accu's	2 x BL1850B
Bijgeleverde accu's	1 x BL1021B
Lader	DC18RE
BL-motor	-
Prijs in €	excl. btw
	incl. btw

DF333DWAJ DF333DWMJ DF332DSAJ DF332DSMJ

Spanning	10,8 V	10,8 V	10,8 V	10,8 V
Bijgeleverde accu's	2 x BL1021B	2 x BL1041B	2 x BL1020B	2 x BL1040B
Hard koppel	30 Nm	30 Nm	35 Nm	35 Nm
BL-motor	-	-	✓	✓
Gewicht	1,1 kg	1,1 kg	1,2 kg	1,2 kg
Prijs in €	excl. btw			
	incl. btw			

ACCU KLOPBOOR- EN SCHROEFMACHINES



HP332DSMJ



HP333DWAJ

HP333DWAJ HP332DSAJ HP332DSMJ

Spanning	10,8 V	10,8 V	10,8 V
Bijgeleverde accu's	2 x BL1021B	2 x BL1020B	2 x BL1040B
Hard koppel	30 Nm	35 Nm	35 Nm
BL-motor	-	✓	✓
Gewicht	1,1 kg	1,1 kg	1,3 kg
Prijs in €	excl. btw		
	incl. btw		

ACCU SLAGSCHROEVENDRAAIERS



TD111DSMJ



TD110DSAJ



Assist modus voor het vlot aanzetten bij het schroeven.

TD110DSAJ TD110DSMJ TD111DZJ TD111DSAJ TD111DSMJ

Spanning	10,8 V	10,8 V	10,8 V	10,8 V	10,8 V
Bijgeleverde accu's	2 x BL1020B	2 x BL1040B	0	2 x BL1020B	2 x BL1040B
Max. koppel	110 Nm	110 Nm	135 Nm	135 Nm	135 Nm
BL-motor	-	-	✓	✓	✓
Assist modus	-	-	✓	✓	✓
Gewicht	1,0 kg	1,0 kg	1,0 kg	1,0 kg	1,0 kg
Prijs in €	excl. btw				
	incl. btw				

SCHROEFBITSET (35 STUKS) IMPACT BLACK



Schroefbitset B-66880  
35 stuks Impact Black



ACCU BOORHAMERS SDS-PLUS



HR166DSMJ



HR140DSAJ

		HR140DSAJ	HR140DSMJ	HR166DSMJ
Spanning		10,8 V	10,8 V	10,8 V
Bijgeleverde accu's		2 x BL1020B	2 x BL1040B	2 x BL1040B
Slagenergie		1,0 J	1,0 J	1,1 J
Max. Ø beton		14 mm	14 mm	16 mm
BL-motor		-	-	✓
Gewicht		1,9 kg	1,9 kg	1,8 kg
Prijs in €	excl. btw			
	incl. btw			

ACCU HAAKSE BOORMACHINES



		DA332DSAJ	DA332DSMJ	DA333DSAJ	DA333DSMJ
Spanning		10,8 V	10,8 V	10,8 V	10,8 V
Bijgeleverde accu's		2 x BL1020B	2 x BL1040B	2 x BL1020B	2 x BL1040B
Boorkop		1,5-10 mm	1,5-10 mm	1,5-10 mm	1,5-10 mm
Gewicht		1,2 kg	1,2 kg	1,2 kg	1,2 kg
Prijs in €	excl. btw				
	incl. btw				

ACCU HAAKSE SLAGSCHROEVENDRAAIERS



TL064DZJ



Opname  
1/4"

TL065DZJ



Opname  
3/8"

		TL064DZJ	TL065DZJ
Spanning		10,8 V	10,8 V
Bijgeleverde accu's		0	0
Toerental		0-2000 t.p.m.	0-2000 t.p.m.
Gewicht		1,2 kg	1,2 kg
Prijs in €	excl. btw		
	incl. btw		

ACCU SLAGMOERSLEUTELS



TW141DSMJ

		TW140DZJ	TW140DSAJ	TW140DSMJ	TW141DZJ	TW141DSMJ	TW160DZJ	TW160DSAJ	TW160DSMJ	TW161DZJ
Spanning		10,8 V	10,8 V	10,8 V	10,8 V	10,8 V	10,8 V	10,8 V	10,8 V	10,8 V
Bijgeleverde accu's		0	2 x BL1021B	2 x BL1041B	0	2 x BL1041B	0	2 x BL1021B	2 x BL1041B	0
Toerental		0-2600 t.p.m.	0-2600 t.p.m.	0-2600 t.p.m.	0-2600 t.p.m.	0-2600 t.p.m.	0-1300 t.p.m. 0-2400 t.p.m.	0-1300 t.p.m. 0-2400 t.p.m.	0-1300 t.p.m. 0-2400 t.p.m.	0-1300 t.p.m. 0-2400 t.p.m.
Max. koppel		140 Nm	140 Nm	140 Nm	145 Nm	145 Nm	165 Nm	165 Nm	165 Nm	165 Nm
Snelheden		1	1	1	1	1	2	2	2	2
Auto-stop functie		-	-	-	-	-	✓	✓	✓	✓
Opname		3/8"	3/8"	3/8"	1/2"	1/2"	3/8"	3/8"	3/8"	1/2"
BL-motor		-	-	-	-	-	✓	✓	✓	✓
Gewicht		1,0 kg	1,0 kg	1,0 kg	1,1 kg	1,1 kg	1,0 kg	1,0 kg	1,0 kg	1,1 kg
Prijs in €	excl. btw									
	incl. btw									

**Reverse Auto-stop:**  
Rotatie stopt automatisch  
wanneer de bout of moer is  
losgedraaid

ACCU RATELMOERSLEUTEL



Geleverd met 1/4" & 3/8" opname

Verwijderbare kop laat toe om 13 mm moeren over de lengte van een M8 draadstang te schroeven.



		WR100DZ
Spanning		10,8V
Toerental onbelast		800 t.p.m.
Max. koppel		47,5 Nm
Bijgeleverde accu's		-
Gewicht		1,0 kg
Prijs in €	excl. btw	
	incl. btw	

ACCU NIETMACHINE



ST113DSAJ

Met repeteerfunctie en anti-droogschietmechanisme

		ST113DZJ	ST113DSAJ	ST113DSMJ
Spanning		10,8V	10,8V	10,8V
Bijgeleverde accu's		-	2 x BL1020B	2 x BL1040B
Rugbreedte niet		10 mm	10 mm	10 mm
Ladercapaciteit		150 stuks	150 stuks	150 stuks
Gewicht		1,3 kg	1,3 kg	1,5 kg
Prijs in €	excl. btw			
	incl. btw			

ACCU PINPISTOOL



PT354DZJ

		PT354DZJ
Spanning		10,8V
Bijgeleverde accu's		-
Draadkaliber		23 Ga
Doorsnede nagel		0,6 mm
Lengte nagel		15-35 mm
Gewicht		2,0 kg
Prijs in €	excl. btw	
	incl. btw	

LUCHTPOMP



MP100DZ

Spanning		10,8V
Bijgeleverde accu's		-
Debiet		10 l/min (bij 2 bar)
Max. druk		8,3 bar
Gewicht		1,2 kg
Prijs in €	excl. btw	
	incl. btw	

ACCU SCHUUR-/POLIJSTMACHINE 75 MM



- Geleverd met adapter voor Roloc™ voor schuurtoepassingen en een velcro steunschijf voor het polijsten
- Ideaal voor oppervlaktebehandeling en voor het polijsten van kleine oppervlakken



		PV301DZJ	PV301DSAEJ
Spanning		10,8V	10,8V
Bijgeleverde accu's		-	2x BL1021B
Capaciteit polijsten		80 mm	80 mm
Capaciteit schuren		50 mm	50 mm
Toerental polijsten		0-2800 min <sup>-1</sup>	0-2800 min <sup>-1</sup>
Toerental schuren		0-9500 min <sup>-1</sup>	0-9500 min <sup>-1</sup>
Gewicht		1,1 kg	1,1 kg
Prijs in €	excl. btw		
	incl. btw		

ACCU CIRKELZAAG 85 MM



HS301DSAJ

		HS301DSAJ	HS301DSMJ
Spanning		10,8V	10,8V
Bijgeleverde accu's		2 x BL1020B	2 x BL1040B
Max. zaagdiepte bij (90°)		25,5 mm	25,5 mm
Ø Zaagblad		85 mm	85 mm
Gewicht		1,6 kg	1,6 kg
Prijs in €	excl. btw		
	incl. btw		

ACCU TEGELSNIJDER 85 MM



CC301DSMJ



		CC301DZJ	CC301DSMJ
Spanning		10,8V	10,8V
Bijgeleverde accu's		-	2 x BL1040B
Zaagdiepte (90°)		25,5 mm	25,5 mm
Ø Zaagblad		85 mm	85 mm
Gewicht		1,9 kg	1,9 kg
Prijs in €	excl. btw		
	incl. btw		

ACCU DRAADSTANGKNIPPER



Voor gebruiksklaar afkorten zonder vonken!

SC103DZJ

Spanning		10,8V
Bijgeleverde accu's		-
Afkorten		Mobiel
Snijscapaciteit		M6 - M8 - M10
Inbegrepen mes		M8, M10
Gewicht		2,7 kg
Prijs in €	excl. btw	
	incl. btw	

ACCU MULTICUTTER



CP100DZJ

Spanning		10,8V
Bijgeleverde accu's		-
Snijscapaciteit		6 mm
Gewicht		0,72 kg
Prijs in €	excl. btw	
	incl. btw	

ACCU GIPSZAAG



SD100DZJ

Spanning		10,8V
Bijgeleverde accu's		-
Slaglengte		6 mm
Snijscapaciteit		30 mm
Gewicht		1,5 kg
Prijs in €	excl. btw	
	incl. btw	



ACCU DECOUPEERZAGEN

10.8V CXT



JV102DSAJ



JV103DSAJ

	JV101DSAJ	JV102DZJ	JV102DSAJ	JV102DSMJ	JV103DZJ	JV103DSAJ	JV103DSMJ
Spanning	10,8V	10,8V	10,8V	10,8V	10,8V	10,8V	10,8V
Bijgeleverde accu's	2 x BL1020B	0	2 x BL1020B	2 x BL1040B	0	2 x BL1020B	2 x BL1040B
Aantal zaagbewegingen	0-2900 /min	800-3000 /min	800-3000 /min	800-3000 /min	800-3000 /min	800-3000 /min	800-3000 /min
Max. capaciteit hout	65 mm	90 mm	90 mm	90 mm	90 mm	90 mm	90 mm
BL-motor	-	✓	✓	✓	✓	✓	✓
Gewicht	1,8 kg	1,8 kg	1,8 kg	1,8 kg	1,8 kg	1,8 kg	1,8 kg
Prijs in €	excl. btw						
	incl. btw						

ACCU RECIPROZAAG

10.8V CXT



JR103DSAJ

	JR103DSAJ	JR103DSMJ
Spanning	10,8V	10,8V
Bijgeleverde accu's	2 x BL1020B	2 x BL1040B
Max. zaagcapaciteit hout/stalen buis	50 mm	50 mm
Gewicht	1,3 kg	1,5 kg
Prijs in €	excl. btw	
	incl. btw	

ACCU MULTITOOl

10.8V CXT



TM30DSAJX3

Spanning	10,8V
Bijgeleverde accu's	2 x BL1020B
Oscillatiehoek	3,2°
Oscillatiefrequentie	6000-20000 min <sup>-1</sup>
Opname	OIS, Starlock
Gewicht	1,1 kg
Prijs in €	excl. btw
	incl. btw

ACCU KITPISTOOL

CXT 10.8V



CG100DSAEA

CG100DSAEB

CG100DSAEB met aluminium kokerhouder 600 ml (voor worsten of kit in bulkverpakking)

	CG100DSAEA	CG100DSAEB
Spanning	10,8V	10,8V
Bijgeleverde accu's	2 x BL1020B	2 x BL1020B
Max. extrusiekracht	5000 N	5000 N
Max. extrusiesnelheid	0-28 mm/s	0-28 mm/s
Prijs in €	excl. btw	
	incl. btw	

ACCU VERWARMD ONDERHEMD

**DCX200 - DCX201**

- DCX200 serie: met open ronde hals. DCX201 serie: met rechtopstaande kraag en halve ritssluiting
- Voeding middels 14,4V/18V LXT-batterij of compacte BL1055B
- Zeer dunne en elastische stof, waardoor het hemd onder andere kleding gedragen kan worden
- Vier warmtezones en 3 warmtestanden
- Machinewasbaar en geschikt voor droogkast



**DEABL1055B**  
Powerbank

prijzen geldig t.e.m. 31/12/2024



DCX200C

DCX201C

		DCX200C	DCX201C
Maat	S-M-L-XL-2XL-3XL		
Voeding	14.4V/18V LXT BL1055B	14.4V/18V LXT BL1055B	
Incl. batterijadapter	TD00000111	TD00000111	
Model	Open hals	Met kraag en halve ritssluiting	
Vermogenniveaus	2,3W / 4,5W / 9,5W	2,3W / 4,5W / 9,5W	
Verwarmingszones	4	4	
Materiaal	100% polyester	100% polyester	
Machine wassen/drogen	✓	✓	
Prijs in €	Excl. BTW		
	Incl. BTW		

VERWARME JASSEN / BODYWARMERS CXT & LXT



CJ106 EN DCJ206:  
HIGH VISIBILITY  
(CONFORM  
ISO 20471/ANSI1107)

CV102 EN DCV202:  
ZONDER MOUWEN  
(BODYWARMER)



CJ106  
DCJ206



CV102  
DCV202

		CJ105DZ	DCJ205Z	CJ106DZ	DCJ206Z	CV102DZ	DCV202Z
Maat	S-M-L-XL-2XL-3XL						
Spanning	10,8V	18V	10,8V	18V	10,8V	18V	
Model	Jas - zwart	Jas - zwart	Jas - High Visibility	Jas - High Visibility	Bodywarmer	Bodywarmer	
Vermogen	2,3W - 7W - 11,5W	2,3W - 7W - 11,5W	2,3W - 7W - 11,5W	2,3W - 7W - 11,5W	2,3W - 4,5W - 9,5W	2,3W - 4,5W - 9,5W	
Verwarmingszones	5	5	5	5	4	4	
Materiaal buitenzijde	Polyester	Polyester	Polyester	Polyester	Polyester Spandex	Polyester Spandex	
Materiaal binnenzijde	Fleece	Fleece	Fleece	Fleece	Fleece	Fleece	
Water- & windresistent	✓	✓	✓	✓	✓	✓	
Machine wassen/drogen	✓	✓	✓	✓	✓	✓	
Aantal zakken	6	6	6	6	4	4	
Prijs in €	Excl. BTW						
	Incl. BTW						

ACCU VERWARMD DEKEN



DCB200B

**GESCHIKT VOOR  
WASMACHINE &  
DROOGKAST**

		CB100DB	DCB200B
Bijgeleverde accu's	0		
Afmetingen (LxB)	700 x 1400 mm		
Vermogen	2,3W - 4,5W - 9,5W		
Materiaal	Polyester		
Spanning	10,8V	14,4V/18V	
Prijs in €	excl. btw		
	incl. btw		

ACCU GEVENTILEERDE VESTEN



Bescherm uzelf tegen de hitte met onze geventileerde vesten op accu!



DFV210Z

Polyester  
Waterafstotend  
**DFV210**  
Zijdellingse ventilatoren



DFV214A01

**DFV214A01 (S-L) /  
DFV214A02 (XL-3XL)**  
Zijdellingse ventilatoren



DFJ212Z

Polyester  
Waterafstotend  
**DFJ212**  
Zijdellingse ventilatoren



DFJ210Z DFJ211Z

Polyester  
Waterafstotend en  
vochtdoorlatend  
**DFJ210/211 (met kap)**  
Zijdellingse ventilatoren  
/



DFJ213Z

Polyester  
Stretch  
**DFJ213**  
Zijdellingse ventilatoren



DFJ304Z

Katoen  
Vochtabsorberend  
**DFJ304**  
Zijdellingse ventilatoren



DFJ214Z

Polyester  
Waterafstotend en  
antistatisch  
**DFJ214**  
Zijdellingse ventilatoren



DFJ410Z DFJ411Z

Polyester met  
titanium coating  
UV- en IR-reflectorend -  
stretch  
**DFJ410/DFJ411 (met kap)**  
Zijdellingse ventilatoren  
/

	maat (cm)	S	M	L	XL	2XL	3XL
■ DFJ212	Lengte			70	71	72	73
	Schouder			48	50	52	54
	Mouw*			93	95	97	99
	Borst			127	132	137	142
	Taille			121	126	131	136
■ DFJ213	Lengte			69	70	71	72
	Schouder			51	53	55	57
	Mouw			66	67	68	69
	Borst			127	132	137	142
	Taille			113 ~ 121	118 ~ 126	123 ~ 131	128 ~ 136
■ DFJ214	Lengte			72	73	74	75
	Schouder			51	53	55	57
	Mouw			66	67	68	69
	Borst			127	132	137	142
	Taille			113 ~ 121	118 ~ 126	123 ~ 131	128 ~ 136
■ DFJ210/DFJ211	Lengte	64	66	68	70	72	74
	Schouder	51.55	4	56.55	9	61.56	4
	Mouw	54	56	58	60	62	64
	Borst	116	121	126	131	136	141
■ DFJ410/DFJ411	Taille	77 ~ 108	82 ~ 113	87 ~ 113	92 ~ 133	97 ~ 113	102 ~ 133
	Lengte			71	72	73	74
■ DFV210	Schouder			47	49	51	53
	Borst			123	128	133	138
	Taille			117	122	127	132

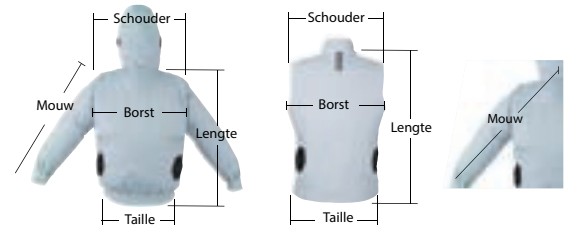

198634-2  
Accu-adaptor LXT-batterijen

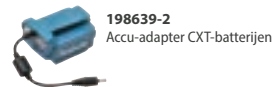

198639-2  
Accu-adaptor CXT-batterijen

ACCU VENTILATOREN

CF003G



Ideaal voor het ventileren van grotere ruimten, zoals magazijnen of werkplaatsen.



Voeding middels XGT/LXT accu's netstroom



Variabele toerentalregeling



	DCF102Z	DCF203Z	DCF301Z	CF001GZ	CF002GZ	CF003GZ
Spanning	18 V / 14,4 V	18 V / 14,4 V	18 V / 14,4 V	36 V (40Vmax) XGT / AC	36 V (40Vmax) XGT / AC	36 V (40Vmax) XGT / 18 V LXT / AC
AC adapter	Optioneel	Optioneel	inclusief	inclusief	inclusief	inclusief
Diameter	180 mm	235 mm	300 mm	235 mm	330 mm	450 mm
Auto zwenken L/R	✓	✓	✓	✓	✓	✓
Timer	✓	✓	✓	✓	✓	✓
Gewicht	1,3 kg	2,5 kg	4,3 kg	2,0 - 3,0 kg	4,5 - 5,1 kg	7,9 - 10,5 kg
Prijs in €	excl. btw					
	incl. btw					



ACCU KOFFIEZETAPPARAAT



Ideaal voor op de bouw- en werkplaats. Werkt zowel met kofiepads als met gemalen koffie. Met één accu (LXT 5,0 Ah) maak je 3 koppen koffie van 160 ml.

DCM501Z

Spanning	10,8V/14,4V/18V
Bijgeleverde accu's	0
Inhoud waterreservoir	240 ml
Bereidingstijd met 18V accu (150 ml)	5 min.
Gewicht	1,9 - 2,2 kg
Prijs in €	excl. btw
	incl. btw

ACCU WATERKOKER



- Dubbellaagse roestvrijstalen wand
- Met voedingsstandaard en groot handvat
- Uitgerust met morsbeveiliging

DKT360Z

DKT360Z

KT001GZ

Spanning	2x18V	36 V (40Vmax)
Inhoud	0,8 l	0,8 l
Kooktijd voor 0,8 l	ca. 8 min	ca. 8 min
Verwarmcapaciteit 100 °C	1,2 l met 2 x BL1850	1,2 l met 2 x BL4025
Gewicht	2,7 - 3,4 kg	2,8 - 5,9 kg
Prijs in €	excl. btw	
	incl. btw	

MINILUCHTPOMP



DMP180Z



Standaard met verschillende ventieladapters



Bedieningspaneel

De DMP181 is uitgerust met een groot display met achtergrondverlichting.



DMP181Z

MP001GZ

DMP180Z DMP181Z MP001GZ

Spanning	18V	18V	36V (40Vmax)
Bijgeleverde accu/lader	-	-	0
Debiet	10 l/min	11 - 22 l/min	12 - 24 l/min
Max. druk	8,3 bar	11,1 bar	11,1 bar
Gewicht	1,5 kg	2,5 - 2,8 kg	2,9 - 3,5 kg
Prijs in €	excl. btw		
	incl. btw		

BLAAS- EN ZUIGMACHINE



- Traploos regelbare snelheid met vario-schakelaar en voorkeuze van 4 maximumsnelheden.
- Verschillende mondstukken beschikbaar voor uiteenlopende toepassingen. Standaard worden 5 mondstukken meegeleverd.
- Kan ook gebruikt worden om lucht weg te zuigen via een speciaal opzetstuk (optioneel).
- Ideaal voor het reinigen van gereedschap en onderdelen. Kan ook gebruikt worden om bijvoorbeeld speelgoed voor op het water op te blazen of snel af te laten.



DAS180RT



DAS180Z DAS180RT AS001GZ

Spanning	18V	18V	36V (40Vmax)
Bijgeleverde accu	-	1x BL1850B	-
Max. debiet	1,1 m³/min	1,1 m³/min	0 - 1,3 m³/min
Blaaskracht	2,8 N	2,8 N	2,8 N
Max. onderdruk	93 mbar	93 mbar	103 mbar
Gewicht	1,2 - 1,7 kg	1,2 - 1,7 kg	1,5 - 2,3 kg
Prijs in €	excl. btw		
	incl. btw		

MICROGOLFOVEN



- Ideaal om voeding op te warmen op plaatsen waar geen netstroom beschikbaar is.
- Werkt met één 40Vmax accu of twee in parallel.
- Compact, gemakkelijk te transporteren.
- Vermogenniveaus: 350W en 500W
- De verwarmingstijd kan ingesteld worden van 10 seconden tot 20 minuten.
- Met 2x BL4040 en op volle vermogen kunnen ongeveer 5 maaltijden of 8 koppen van 200 ml opgewarmd worden.

MW001GZ	
Spanning	36V (40Vmax)
Bijgeleverde accu's	-
Bijgeleverde lader	-
Inhoud	8 l
Binnenafmetingen	255 x 241 x 120 mm
Uitgangsvermogen	350 W / 500 W
Autonomie (2x BL4040)	350 W: 21 min 500 W: 15 min
Gewicht	9,5 - 12,7 kg
Prijs in €	excl. btw
	incl. btw

VRIES-/ KOELBOX MET VERWARMFUNCTIE



CW004G

- Capaciteit van 29 l
- Uiterst efficiënt en groot koelvermogen door het gebruik van een compressor
- De ruimte kan onderverdeeld worden in twee vakken met elk een eigen temperatuurinstelling, bijvoorbeeld een koel- en vriesvak. Standaard geleverd met binnenbakje en binnenmand
- Het deksel kan aan beide zijden geopend worden of volledig verwijderd voor het gemakkelijk reinigen
- Met beugel om te rollen op de wielen en ook voorzien van inklapbare handvaten zijdelings om gemakkelijk te dragen



CW003GZ



CW004GZ



CW004GZ



CW002GZ01



CW004GZ

	CW003GZ	CW001GZ01	CW004GZ	CW002GZ01
Voeding	36V (40Vmax) XGT / 18V LXT / AC / 12V DC - 24V DC	36V (40Vmax) XGT / 18V LXT / AC / 12V DC - 24V DC	36V (40Vmax) XGT / 18V LXT / AC / 12V DC - 24V DC	36V (40Vmax) XGT / 18V LXT / AC / 12V DC - 24V DC
Inhoud	7 l	20 l	29 l	50 l
Koelen	-18 / -15 / -10 / -5 / 0 / 5 / 10 °C	-18 / -15 / -10 / -5 / 0 / 5 / 10 °C	-18 / -15 / -10 / -5 / 0 / 5 / 10 °C	-18 / -15 / -10 / -5 / 0 / 5 / 10 °C
Verwarmen	30 / 35 / 40 / 45 / 50 / 55 / 60 °C	30 / 35 / 40 / 45 / 50 / 55 / 60 °C	30 / 35 / 40 / 45 / 50 / 55 / 60 °C	30 / 35 / 40 / 45 / 50 / 55 / 60 °C
Autonomie ca.	-18 °C: 5,5 uur, 5 °C: 13,5 uur, 60° C: 5,5 uur (1x BL4040)	-18 °C: 8 uur, 5 °C: 22,5 uur, 60° C: 7 uur (2x BL4040)	-18 °C: 10,0 h, 5 °C: 24,0 h (at 30 °C) 60 °C: 9,0 h (at 0° C) Dual room mode (left -18 °C, right 5 °C): 9,0 h	-18 °C: 8 uur, 5 °C: 19,5 uur, 60° C: 4,5 uur (2x BL4040)
Afmetingen	456 x 245 x 308 mm	663 x 341 x 372 mm	676 x 345 x 471 mm	867 x 465 x 476 mm
Gewicht	7,9 - 9,4 kg	13,8 - 17,3 kg	17,5 - 20,9 kg	25,6 - 29,0 kg
Prijs in €	excl. btw			
	incl. btw			



ACCU BLUETOOTH-SPEAKERS



**DMR203**

BLUETOOTH-SPEAKER  
MET KOPPELFUNCTIE

Equalizer

Koppelbaar  
per 2: True Wire-  
less Stereo tot 10:  
simultaan luisteren



ACCU RADIO'S



**MR014GZ**

BLUETOOTH-SPEAKER



Smartphone  
stand



Microfoon-  
aansluiting met  
ingebouwde  
versterker



**MR014GZ**

**NIEUW**

- Hoge geluidskwaliteit met diepe bastonen dankzij nieuwe decoders, een grote woofer en twee passieve radiators
- Microfoonaansluiting met ingebouwde versterker
- Bluetooth bereik tot 30 m
- Twee toestellen kunnen gecombineerd worden voor stereogeluid, en tot 10 toestellen om overal muziek te kunnen beluisteren in grotere complexen.
- Met equalizer, groot kleurdisplay en actieve led decoratie rondom de speaker.
- Uitstekende IP65 bescherming tegen water en stof



**DMR056**  
RADIO MET  
LANTAARN LXT



**MR009GZ**  
RADIO MET  
LANTAARN XGT

**PROMO**

Gratis multistool  
PGC-120040  
bij MR014GZ,  
MR004GZ,  
MR007GZ en  
DMR056



DMR301 met laadfunctie voor LXT / CXT accu's



GEREEDSCHAPSETS IN KOFFER

Onze favoriet!  
E-10883: 221-delige gereedschapskoffer voor kleine herstellingen



Scan mij voor meer info!



**E-10883**  
GEREEDSCHAPSET  
221-DELIG

MAKPAC OPBERGSYSTEEM



- Inclusief 5 types van bakjes : 150x150 mm (1), 150x100 mm (1), 100x100 mm (2), 100x50 mm (3) en 50x50 mm (6)
- Bijkomende inzetbakjes zijn apart te verkrijgen
- Flexibel indeelbaar
- Koppelbaar met Makita Makpacs, Makstors, Makpac trolley TR00000001 en Makpac transportkar P-83886

**191X80-2**  
395 x 295 x 110 mm  
2.3 kg

MAKSTORS



P-84311 Makstor nr. 3 met 4 lades.



P-84333 Makstor nr. 3 met 6 lades



P-84327 Makstor nr. 3 met 12 lades



P-84349 Makstor nr. 4 met 5 lades

Koppelbaar met alle Makita Makpacs, alsook met Makpac IV koelbox 198253-4, de Makpac trolley TR00000001 en de Makpac transportkar P-83886

De lades van de Makstor zijn flexibel indeelbaar. Standaard worden er bij deze Makstor 8 verdelers / tussenschotten geleverd. De lades zijn voorzien van een vergrendelingssysteem en kunnen gelabeld worden

IDEAAL OM LOS MATERIAAL IN TE BEWAREN ZOALS BOREN EN BITSEN

Omschrijving	Ref.	Indeling	Afmetingen	Prijs excl. btw	Prijs incl. btw
Makstor nr. 3-4	P-84311	4 lades (1 groot / 2 klein / 1 middelgrote)	395 (L) x 295 (B) x 210 (H) mm		
Makstor nr. 3-12	P-84327	12 kleine lades	395 (L) x 295 (B) x 210 (H) mm		
Makstor nr. 3-6	P-84333	6 middelgrote lades	396 (L) x 295 (B) x 210 (H) mm		
Makstor nr. 4-5	P-84349	5 lades (2 groot / 2 klein / 1 middelgrote)	395 (L) x 295 (B) x 320 (H) mm		

# LAMPEN

## ZAKLAMPEN CXT



	DEAML103	DEAML104	DEAML105	DEAML106
Spanning	10,8 V (12Vmax)	10,8 V (12Vmax)	10,8 V (12Vmax)	10,8 V (12Vmax)
Max. lichtstroom	100 lm	710 lm	190 lm	190 lm
Verlichtingssterkte op 1 m	50 lx	340 lx (0,5 m, lantaarn)	5500 lx	170 - 4500 lx
Werkingsduur bij max intensiteit, accu BL1041B	28 u.	5,5 u.	14 u.	12 u.
Specifieke functionaliteiten	Uiterst compact	Lantaarn (360°) en zaklamp (gericht) USB uitgang	Reflector in 12 posities verstelbaar	Zoom functie
Afmetingen	77 x 54 x 28 mm	414 x 66 x 132 mm	249 x 66 x 93 mm	271 x 66 x 93 mm
Gewicht	0,27 - 0,43 kg	0,61 - 0,78 kg	0,53 - 0,7 kg	0,61 - 0,78
Prijs in €	excl. btw			
	incl. btw			

**DEADML105 - DEADML815 - DEAML001G**  
Reflector 170° kantelbaar in 12 stappen

170°



**DEADML104 - DEBDML806 - DEBDML807 - DEAML002G**

3 modi: 360° zijdelings licht, 180° zijdelings licht en gericht licht (bovenaan).  
USB uitgang Type A: 5V 2,4 A (behalve DEBDML806)

3 MODI

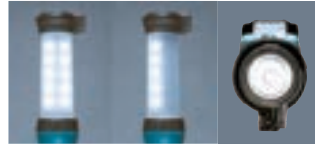

USB uitgang



**BEADML810**

Ontwerp met laag zwaartepunt zodat de lamp niet kan omvallen



## WERFLAMPEN LXT



	DEADML805	DEADML809	BEADML810	DML813	DML814
Spanning	18 V / 14,4 V / AC	18 V / 14,4 V / AC	18 V / 14,4 V / AC	18 V / 14,4 V	18 V / 14,4 V
Max. lichtstroom	750 lm	10000 lm	5500 lm	3000 lx	3000 lx
Verlichtingssterkte op 1 m	300 lx	3800 lx	550 lx	1250 lx	1250 lx
Verlichtingssterkte op 3 m	-	380 lx	70 lx	130 lx	130 lx
Verlichtingssterkte op 5 m	-	150 lx	25 lx	50 lx	50 lx
Verlichtingscapaciteit naar voor/zijdelings	-	10 m/10 m	360°, ± 4 m	4,5 m/5,3 m	4,7 m/5,6 m
Werkingsduur bij max intensiteit, accu BL1850B	8,5 u.	1,4 u (2x BL1850B)	3,5 u.	3 u. (2xBL1850B)	3 u. (2xBL1850B)
Specifieke functionaliteiten	DC/AC 2 helderheidsniveaus	DC/AC 3 helderheidsniveaus	DC/AC 3 helderheidsniveaus	Geïntegreerd statief	Geïntegreerd statief Met 3 afzonderlijk richtbare lichtunits
Afmetingen	214 x 261 x 328 mm	249 x 379 x 370 mm	420 x 420 x 787 mm	573 x 658 x 1250-2240 mm	573 x 658 x 1250-2240 mm
Gewicht	2,3 - 2,7 kg	5,7 - 7,0 kg	13,9 - 15,3 kg	7,2 - 7,9 kg	7,4 - 8,1 kg
Prijs in €	excl. btw				
	incl. btw				

**DML813-DML814**

Uitschuifbaar van 1250 mm tot 2240 mm  
Gemakkelijk opvouwbaar voor transport



**EUAML010GZ**

Voeding middels XGT accu's, LXT accu's of netstroom  
• Tot 4 accu's kunnen tegelijkertijd gemonteerd worden  
• Kan tot 80° kantelen zonder om te vallen  
• Werktijd bij maximum intensiteit: 8,5 uur (2x BL4050F)  
• Beschermingsklasse IP54 (bij werking op accu)

ZAKLAMPEN LXT



	DEADML803	DEBDML186	DEBDML800	DEBDML815	DEBDML808	DEADML816	DECDML807	DEADML817	DEBDML812	EUADML818
Spanning	18V/14,4V	18V/14,4V	18V/14,4V	18V/14,4V	18V/14,4V	18V/14,4V	18V/14,4V	18V/14,4V	18V/14,4V	18V
Max. lichtstroom	170 lm	-	100 lm	160 lm	190 lm	500 lm	710 lm (lantaarn)	300 lm	1000 lm (flood)	1700 lumen
Verlichtingssterkte op 1 m	270 lx (0,5 m)	500 lx	2000 lx	3000 lx	170 - 4500 lx	800 lx (1m)	340 lx (0,5 m, lantaarn)	240 lx (0,5 m)	520 lx (0,5 m flood)	600 lx
Werkingsduur bij max intensiteit, accu BL1850B	26 u.	83 u.	33 u.	45 u.	26 u.	75 h	23 u.	23 u.	6,5 u (flood)	4 u
Specifieke functionaliteiten	Batterijhouder met riembevestiging	Met handriem	Hoofdlamp	Reflector in 12 posities kantelbaar	Zoom functie	Reflector draaibaar en kantelbaar	Lantaarn (360°) en zaklamp (gericht) USB uitgang	3 verlichtingsmodi USB uitgang	Modi: spot, flood, spot + flood	3 helderheidsinstellingen
Afmetingen	133 x 81 x 72 mm	151 x 81 x 61 mm	133 x 76 x 88 mm	256 x 79 x 99 mm	280 x 79 x 10 mm	383 x 79 x 110 mm	414 x 79 x 155 mm	107 x 77 x 50mm	313 x 119 x 115 mm	972 x 80 x 134 cm
Gewicht	0,56 - 0,92 kg	0,51 - 0,83 kg	0,58 - 0,64 kg	0,26 - 0,93 kg	0,73 - 1,09 kg	0,70 - 1,1 kg	0,72 - 1,1 kg	0,51 - 0,88 kg	1,2 - 1,6 kg	1,7 kg
Prijs in €	excl. btw									
	incl. btw									

DEADML816 - DEAML006G

De lichtkop is draaibaar, kantelbaar en opvouwbaar



**Lichtstroom (Lumen, lm):** de hoeveelheid uitgestraald licht per tijdseenheid. Het is een maat voor het vermogen van de lamp.

**Verlichtingssterkte (Lux, lx):** de lichtstroom per oppervlakte of dus de mate waarin een vlak verlicht wordt. De verlichtingssterkte is afhankelijk van de afstand tot de lichtbron.

**Verlichtingscapaciteit:** de zone waar de verlichtingssterkte minstens 70 lx is (de verlichtingssterkte die minimaal nodig is om veilig te kunnen werken).

EUADML818 - EUML012G

- LED-lichtbalk met brede verlichting
- Versie EUADML818 voor gebruik met 14,4/18V LXT accu's, versie EUML012G voor XGT
- 3 helderheidsinstellingen: 400 / 800 / 1700 lumen
- Ideaal voor bijvoorbeeld autogarages en pechverhelpingsdiensten. Met de meegeleverde telescopische haak kan het apparaat aan de motorkap of achterdeur van een voertuig bevestigd worden.
- De LED-lichtbalk bestaat uit twee delen en kan in tweeën worden gevouwen.
- De bovenste en onderste helft van de lichtbalk kunnen afzonderlijk ingeschakeld worden
- De verlichtingshoek kan gekozen worden door de lichtbalk te draaien (7 standen)



WERFLAMPEN LXT & XGT



	DEAML003G	DEAML005G	DEAML009G	EUAML010G	EUAML012G
Spanning	36V (40Vmax) /18V	36V (40Vmax) /18V	36V (40Vmax) /18V	40Vmax /18V / 14,4V / AC	40Vmax
Max. lichtstroom	1100 lm	3600 lm	10000 lm	5500 lm	1700 lm
Verlichtingssterkte op 1 m	500 lx	2100 lx	4300 lx	550 lx	600 lx
Verlichtingssterkte op 3 m	-	230 lx	500 lx	70 lx	-
Verlichtingssterkte op 5 m	-	90 lx	110 lx	25 lx	-
Verlichtingscapaciteit naar voor/zijdelings	2,8 m/3,0 m	6,0 m/6,4 m	9,7 m/11,4 m	360°, ± 4 m	3,0 m, 3,3 m
Werkingsduur bij max intensiteit, accu BL4040	10 u.	3,5 u.	2,4 u.	6,5 u (2x BL4040)	7 u
Specifieke functionaliteiten	2 helderheidsinstellingen	3 helderheidsinstellingen	3 helderheidsinstellingen	DC/AC 3 helderheidsniveau's	3 helderheidsinstellingen
Afmetingen	249 x 298 x 280 mm	248 x 309 x 296 mm	248 x 386 x 305 mm	490 x 490 x 814 mm	972 x 85 x 138 mm
Gewicht	3,7 - 4,7 kg	4,6 - 6,5 kg	6,4 - 9,9 kg	14,4 - 19,2 kg	2,0 kg
Prijs in €	excl. btw				
	incl. btw				

ACCESSOIRES



Statief voor DML805  
GM00002283



Spanvijs voor DML805  
GM00001396



Statief voor DML809 / DML811 / ML003G-  
GM00002073



STEELOFZUIGERS MET GEÏNTEGREERDE ACCU



	CL114FDWIX	CL117FDX2	CL117FDX5	CL117FDX8
Spanning	10,8 V	10,8 V	10,8 V	10,8 V
Bijgeleverde accu's	Geïntegreerd	Geïntegreerd	Geïntegreerd	Geïntegreerd
Max. debiet	1,4 m³/min	1,0 m³/min	1,0 m³/min	1,0 m³/min
Max. onderdruk	34 mbar	50 mbar	50 mbar	50 mbar
Stofopvang	Stofzak	Capsule	Capsule	Capsule
Klikvergrendeling	✓	✓	✓	✓
Kleur	Beige	Turquoise	Groen	Purper
Promo	-	-	-	-
Gewicht	0,94 kg	1,0 kg	1,0 kg	1,0 kg
Prijs in €	excl. btw			
	incl. btw			
	btw			

CYCLONMODULE

- ✓ Het grove stof wordt van het fijne stof gescheiden.
- ✓ Stofzak of capsule voor het fijn stof tot 80 % minder vaak ledigen!
- ✓ Het reservoir van de module is zeer gemakkelijk te ledigen en uit te wassen.

Gemakkelijk te ledigen

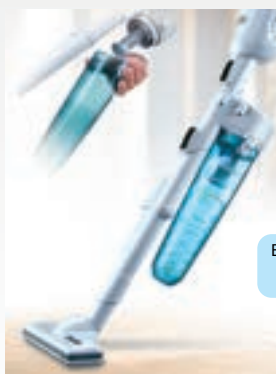

191D71-3

Extra opvangcapaciteit  
**400 ml**



Ref.	Kleur	Prijs excl. btw	Prijs incl. btw
Cyclonmodule met klikvergrendeling			
191D71-3	wit		
191D73-9	zwart		
Cyclonmodule zonder klikvergrendeling			
199491-1	wit		
191d75-5	zwart		

OPTIONELE ACCESSOIRES



Muurbevestiging  
199971-7



Vloerzuigmond tapijt  
198527-3



Kierzuigmond lang  
198990-0



Ronde borstel  
198553-2

NIEUW



Steeloffzuigerstandaard  
1911L1-0

STEELOFZUIGERS CXT/ LXT



PROMO:  
DCL182Z: gratis cycloon 199491-1  
DCL284FZB: gratis cycloon 191D71-3

DCL284, DCL285 & DCL286:

- Nieuwe brushless motor levert hoge zuigkracht.
- Laag geluidsniveau door vernieuwd ontwerp van luchtuitlaat.
- De DCL286 heeft een ingebouwde cyclonmodule: deze vangt grove stofdeeltjes op waardoor de optimale zuigkracht langer behouden blijft.



	CL102DW	CL107FDZW	DCL180ZB	DCL182Z	DCL284FZB	DCL284FRFB	DCL285FZ	DCL285FRF	DCL286FZW	DCL286FRFW
Spanning	10,8V	10,8 V (CXT)	18 V (LXT)	18 V (LXT)	18 V (LXT)	18 V (LXT)	18 V (LXT)	18 V (LXT)	18 V (LXT)	18 V (LXT)
Bijgeleverde accu's	1 x BL1013	-	-	-	-	1x BL1830	-	1x BL1830	-	1x BL1830
Max. debiet	0,9 m³/min	1,4 m³/min	1,4 m³/min	1,4 m³/min	1,2 m³/min	1,2 m³/min	1,2 m³/min	1,2 m³/min	1,0 m³/min	1,0 m³/min
Max. onderdruk	23 mbar	50 mbar	42 mbar	54 mbar	180 mbar	180 mbar	180 mbar	180 mbar	180 mbar	180 mbar
Stofopvang	Stofzak	Stofzak	Capsule	Stofzak	Capsule	Capsule	Stofzak	Stofzak	Cycloon	Cycloon
Klikvergrendeling	-	-	-	-	✓	✓	✓	✓	✓	✓
BL motor	-	-	-	-	✓	✓	✓	✓	✓	✓
Kleur	Wit	wit	Zwart	Blauw	zwart/turquoise	zwart/turquoise	Blauw	Blauw	Wit	Wit
Gewicht	1,1 kg	1.1 - 1.3 kg	1,2 kg	1,3 kg	1.3 - 1.6 kg	1.3 - 1.6 kg	1.4 - 1.7 kg	1.4 - 1.7 kg	1.6 - 1.9 kg	1.6 - 1.9 kg
Prijs in €	excl. btw									
	incl. btw									

XGT STEELSTOFZUIGERS



CL002GD205

CL001GD208



CL002GD212

CL003GZ04

		CL001GZ05	CL001GD208	CL002GZ03	CL002GD205	CL002GZ07	CL002GD212	CL003GZ04
Spanning		40Vmax	40Vmax	40Vmax	40Vmax	40Vmax	40Vmax	40Vmax
Bijgeleverde accu's		-	2x BL4025	-	2x BL4025	-	2x BL4025	-
Bijgeleverde lader		-	DC40RA	-	DC40RA	-	DC40RA	-
Max. debiet		1,2 m³/min	1,2 m³/min	1,2 m³/min	1,2 m³/min	1,2 m³/min	1,2 m³/min	1,0 m³/min
Max. onderdruk		210 mbar	210 mbar	210 mbar	210 mbar	210 mbar	210 mbar	200 mbar
Stofopvang		Capsule	Capsule	Stofzak	Stofzak	Stofzak	Stofzak	Cycloon-capsule
Klikvergrendeling		✓	✓	✓	✓	✓	✓	✓
Kleur		Turquoise	Turquoise	Zwart	Zwart	Wit	Wit	Zwart
Gewicht		1,7 - 2,3 kg	1,7 - 2,3 kg	1,7 - 2,3 kg	1,7 - 2,3 kg	1,7 - 2,3 kg	1,7 - 2,3 kg	1,9 - 2,5 kg
Prijs in €	excl. btw							
	incl. btw							

CLEANING COMBOPACK



CLX245SAX1

Spanning	10,8V
Meegeleverde accu's	1 x BL1021B
Lader	DC10SB
Stofstofzuiger	CL108FDZW
Blaas-/ zuigmachine	UB100DZ
Gereedschapstas	✓
Prijs in €	excl. btw
	incl. btw

ACCUCYCLOONSTOFZUIGER



DCL501Z

DCL501Z

Spanning	18V
Bijgeleverde accu's	0
Max. debiet	1,3 m³/min
Max. onderdruk	66 mbar
Gewicht	3,1 kg
Prijs in €	excl. btw
	incl. btw

# Technologie



Auto-start wireless system

## Geniet van stofvrij werken met AWS!

Bij het starten van de accumachine wordt de stofzuiging automatisch geactiveerd d.m.v. een Bluetooth verbinding. Wanneer het verbonden toestel uitgeschakeld wordt, gaat de stofzuiger weer in stand-by modus. Sommige accustofzuigers zoals VC009 of DVC867 hebben AWS reeds standaard ingebouwd en kunnen dus rechtstreeks communiceren met AWS-compatibele gereedschappen.

Via de optionele adapter WUT02U kunnen nu ook stofzuigers op netstroom draadloos aangestuurd worden, ongeacht het merk. De enige vereiste is dat de stofzuiger met een startautomatiek uitgerust is.

AWS-compatibele stofzuiger



Stofzuiger met startautomatiek



Bluetooth unit 198900-7



### ACCU BLAAS- EN ZUIGMACHINE



UB101DZ & DUB186: uitvoering met lange pijp, ideaal om laag bij de grond te blazen.

prijzen geldig t.e.m. 31/12/2024



	UB100DZ	UB101DZ	DUB185Z	DUB186Z
Spanning	10,8V	10,8V	18 V	18 V
Max. luchtsnelheid	75 m/s	65 m/s	98 m/s	68 m/s
Max. debiet	2,6 m³/min	2,6 m³/min	3,2 m³/min	3,2 m³/min
Gewicht	1,4 kg	1,4 kg	1,6 kg	1,6 kg
Prijs in €	excl. btw			
	incl. btw			

### BLAAS- EN ZUIGMACHINE 230V



Multifunctionele schakelaar met snelheidsinstelling

	UB1103
Vermogen	600 W
Max. luchtsnelheid	91 m/s
Max. debiet	4,1 m³/min
Gewicht	2,0 kg
Prijs in €	excl. btw
	incl. btw



ACCU RUGGEDRAGEN STOFZUIGERS



DVC660

DVC665



DVC660  
Uitvoering speciaal voor schoonmaak, geleverd met diverse accessoires.

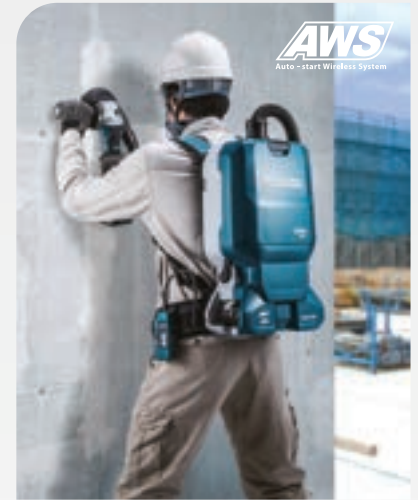

DVC665  
Uitvoering voor stofafzuiging in combinatie met machines.



**HEPA-filter**

Als hoofdfilter wordt een HEPA-filter gebruikt die zeer fijne stofdeeltjes effectief tegenhoudt. De filter kan tot 99,97 % van de deeltjes tussen 0,3 en 1 µm filteren, waardoor de uitgeblazen lucht zeer zuiver is.



**Filterreiniging**

Door de trillingen van het stappen of het manueel indrukken van de hendel wordt het fijn stof van de papierfilter geschud. Daardoor blijft de zuigkracht langer optimaal bij het opzuigen van fijn stof.



**DVC265ZXU DVC261ZX11 DVC660Z DVC665ZX1U**

Spanning	2 x 18V	2 x 18V	2 x 18V	2 x 18V
Max. debiet	1,8-2,2 m³/min	1,8-2,2 m³/min	1,8-2,2 m³/min	1,8-2,2 m³/min
Max. onderdruk	110 mbar	110 mbar	110 mbar	110 mbar
Uitvoering	Stofafzuiging machines	Schoonmaak	Schoonmaak	Stofafzuiging machines
Capaciteit stofzak	2 l	2 l	6 l	6 l
AWS	✓	-	-	✓
Gewicht	3,9 kg	3,8 kg	6,1 kg	6,1 kg
Prijs in €	excl. btw			
	incl. btw			

ACCU RUGGEDRAGEN STOFZUIGERS



VC011G



VC008G



VC009G

(Geleverd zonder batterijen en zonder oplader)



VC011G

Zeer comfortabel harnas

**VC008G-VC009G**

- Hogere zuigkracht dankzij de 40Vmax accutechnologie
- Geluidsarm door een hertekend design van de luchtuitlaat en gebruik van geluidsabsorberend materiaal.
- VC008GZ wordt standaard geleverd met accessoires voor schoonmaakt toepassingen.
- VC009GZ01 wordt geleverd met twee zuigslangen en hulpstukken voor stofafzuiging in combinatie met machines.

**VC011G**

- Verhoogde autonomie dankzij 2 x XGT accu's parallel
- Werktijd met 2 x BL4050F: tot 260 min (min vermogen) en 40 min (max vermogen).
- Hoog luchtdebiet en hoge zuigkracht
- Stille werking
- Automatisch zelfreinigende filter
- Zeer comfortabel harnas

**VC008GZ VC009GZ01 VC011GZ**

Spanning	40Vmax	40Vmax	40Vmax
Max. debiet	2,4 m³/min	1,9 m³/min	2,4 m³/min
Max. onderdruk	180 mbar	180 mbar	200 mbar
Uitvoering	Schoonmaak	Stofafzuiging machines	Schoonmaak
Capaciteit stofzak	2,0 l	2,0 l	6,0 l
AWS	-	✓	-
Gewicht	4,1 - 5,3 kg	4,1 - 5,3 kg	6,4 - 9,5 kg
Prijs in €	excl. btw		
	incl. btw		



VC011GZ

ACCU RECHTOPSTAANDE STOFZUIGER

18V + 18V → 36V

DVC560 - VC010G

- Zeer wendbare alles-in-één stofzuiger (geen netsnoer of zuigslang)
- Hoge stofopname door de combinatie van roterende borstel en stofzuigsysteem, ideaal voor hoogpollige en laagpollige tapijten. Telescopische aluminium handgreep



Instelbare hoogte van de borstel



Geïntegreerde aluminium pijp om moeilijk bereikbare plaatsen te reinigen

de behuizing kan tot 90° scharnieren om gemakkelijk onder meubilair te stofzuigen.

VC010G

- Verhoogde stofopname
- Bredere vloerborstel
- 5-traps hoogteverstelling van de borstelrol
- Vloerborstel met zeer laag profiel



DVC560Z



VC010GZ

		DVC560Z	VC010GZ
Spanning		2 x 18V	40Vmax
Bijgeleverde accu's		-	-
Max. debiet		1,9 m³/min	1,8 m³/min
Max. onderdruk		120 mbar	150 mbar
Gewicht		8,3 - 9,0 kg	8,0 - 9,2 kg
Prijs in €	excl. btw		
	incl. btw		



ACCU COMPACTE STOFZUIGER

LXT 18V LITHIUM-ION



Inclusief draagriem, vloerzuigmond & kierzuigmond

DVC750LZX1

Spanning		18V
Bijgeleverde accu's		0
Max. debiet		1,4 m³/min
Max. onderdruk		64 mbar
Gewicht		4,2 kg
Prijs in €	excl. btw	
	incl. btw	

ACCU COMPACTE STOFZUIGER

12V max LITHIUM-ION

18V LITHIUM-ION

IDEAAL VOOR DE AUTO



DCL184Z

Met blaasfunctie

Inclusief accessoires

CL121DZJ DCL184Z

Spanning		10,8V	18V
Bijgeleverde accu's		-	-
Lader		-	-
Max. debiet		1,3 m³/min	1,3 m³/min
Max. onderdruk		44 mbar	47 mbar
Gewicht		1,7	2,1 kg
Prijs in €	excl. btw		
	incl. btw		

Zuigmond voor matten



Zuigmond voor zetels



Rubberen zuigmond



Zachte borstel

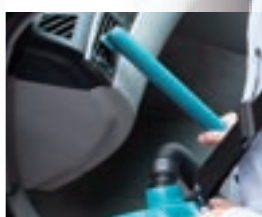

Blaasmond



ACCU ROBOTSTOFZUIGERS



OPPERVLAKTE  
TOT 500 m<sup>2</sup>

**DRC200**

- Verschillende sensoren voor obstakel- en grensdetectie
- Patroonmodus voor grote vloeroppervlakken met weinig obstakels, zoals een magazijn of een lange gang
- Willekeurige modus voor vloeroppervlakken met veel obstakels, zoals in een kantoor.
- Door middel van grenstape kan de gebruiker de zone afbakenen waarbinnen de robot mag werken.
- Modi "alleen borstelen" of "stofzuigen + borstelen"
- Bediening op het toestel zelf of met bijgeleverde afstandsbediening
- Werkt op één 18 V accu of twee in parallel. De accu's moeten uit het toestel verwijderd worden om op te laden.



DRC200PTJ

**Patroonmodus**

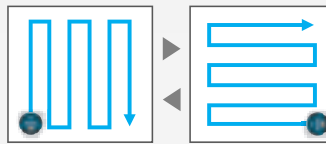

**Willekeurige modus**

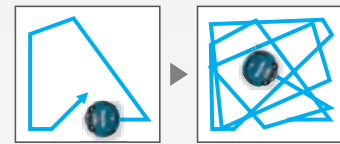

OPPERVLAKTE  
TOT 600 m<sup>2</sup>



DRC300Z



De camera maakt beelden van het plafond ter ondersteuning van de navigatie



**DRC300**

- Kan ruimtes in kaart brengen door gebruik te maken van LiDAR module en beeldcamera. Tot 5 ruimtes kunnen in het geheugen bewaard worden. Dankzij de intelligente positiebepaling kan een ruimte efficiënter gereinigd worden en kan de machine ook automatisch terugkeren naar het beginpunt
- Verschillende sensoren voor obstakel- en grensdetectie
- Modi "alleen borstelen" of "stofzuigen + borstelen"
- Bediening op het toestel zelf, met de afstandsbediening of met de smartphone app (Wifi verbinding)
- Via de smartphone app kunnen de bewaarde kaarten weergegeven en geoptimaliseerd worden (bv. het definiëren van verboden zones) en kan ook schoonmaakstatus en -historiek gecontroleerd worden
- Werkt op één 18 V accu of twee in parallel. De accu's moeten uit het toestel verwijderd worden om op te laden.

**DRC200Z DRC200PTJ DRC300Z**

Spanning		18 V (één of 2 in parallel)		
Bijgeleverde accu's		-	2 x BL1850B	-
Lader		-	DC18RD	-
Capaciteit opvangbak		2,5 l	2,5 l	3,0 l
Max. registreerbare oppervlakte		-	-	10000 m <sup>2</sup>
Max. snelheid		0,3 m/s	0,3 m/s	0,3 m/s
Navigatie		Willekeurig of vast patroon	Willekeurig of vast patroon	Intelligent op basis van kaart
LiDAR sensor		-	-	✓
Camera		-	-	✓
Configuratie en besturing met app		-	-	✓
Afbakenen van verboden zones		Tape	Tape	Tape of via app
Terugkeren naar beginpunt		-	-	✓
Gewicht		6,8 - 7,8 kg	6,8 - 7,8 kg	9,6 - 10,6 kg
Prijs in €	excl. btw			
	incl. btw			



ACCU STOFZUIGERS L-KLASSE LXT



DVC155LZX2



DVC867LZX4



DVC157LZX3



	DVC150LZ	DVC155LZX2	DVC867LZX4	DVC157LZX3
Spanning	2 x 18 V / 230 V	2 x 18 V	2 x 18 V	2 x 18 V
Bijgeleverde accu	-	-	-	-
Kuipvolume	15 l	15 l	8 l	15 l
Type	Nat & Droog	Nat & Droog	Droog	Droog
Filter	Textielfilter	Textielfilter	HEPA	HEPA
Max. debiet	2,1 / 3,6 m <sup>3</sup> /min	2,1 m <sup>3</sup> /min	2,4 m <sup>3</sup> /min	2,4 m <sup>3</sup> /min
Max. onderdruk	90 / 240 mbar	110 mbar	110 mbar	110 mbar
AWS	-	-	✓	✓
Gewicht	8,9 kg	7,9 kg	7,8 kg	8,0 kg
Prijs in €	excl. btw			
	incl. btw			

ACCU STOFZUIGERS L-KLASSE XGT



VC003GLZ

VC004GLZ

VC005GLZ



- Voeding met twee 40Vmax accu's in parallel.
- Hoge zuigkracht dankzij hoger vermogen en verbeterde koeling.
- Met telescopische steel (VC001G/VC003G/VC005G)
- Vloerborstel met laag profiel en verstelling voor harde vloer of tapijt (VC001G/VC003G/VC005G).
- VC005G: hoge wendbaarheid en stabiliteit door extra grote wielen achteraan.

**Toepassing:**

- VC001G / VC003G: voor algemeen droog en nat gebruik (schoonmaak).
- VC002G/VC004G: ideaal voor stofafzuiging van machines (met HEPA filter en AWS).
- VC005G: voor algemeen droog gebruik (schoonmaak).

	VC001GLZ	VC003GLZ	VC002GLZ01	VC004GLZ01	VC005GLZ
Spanning	36 V (40Vmax)	36 V (40Vmax)	36 V (40Vmax)	36 V (40Vmax)	36 V (40Vmax)
Bijgeleverde accu's	-	-	-	-	-
Type	Droog/Nat	Droog/Nat	Droog	Droog	Droog
Capaciteit	8 l	15 l	8 l	15 l	8 l
Max. debiet	3,2 m <sup>3</sup> /min	3,2 m <sup>3</sup> /min	1,8 m <sup>3</sup> /min	1,8 m <sup>3</sup> /min	2,8 m <sup>3</sup> /min
Max. onderdruk	230 mbar	230 mbar	230 mbar	230 mbar	230 mbar
Filter	Textielfilter	Textielfilter	HEPA	HEPA	Textielfilter
AWS	-	-	✓	✓	-
Gewicht	8,1 - 10 kg	8,1 - 10 kg	8,3 - 10,2 kg	8,3 - 10,2 kg	7,9 - 9,8 kg
Prijs in €	excl. btw				
	incl. btw				

**WAT BETEKEN L-, M- OF H-KLASSE?**

Stofzuigers voor professioneel gebruik worden volgens EN60335-2-69 ingedeeld in risicoklassen:

**L-klasse** (Low risk) stofzuigers mogen gebruikt worden voor alle stof waarvan de toelaatbare blootstellingswaarde groter is dan  $1 \text{ mg/m}^3$ . Deze stofzuigers laten minder dan 1 % van het opgezogen stof door.

**M-klasse** (Medium risk) stofzuigers mogen gebruikt worden voor alle stof waarvan de toelaatbare blootstellingswaarde groter is dan  $0,1 \text{ mg/m}^3$ . Deze stofzuigers laten minder dan 0,1 % van het opgezogen stof door en voldoen bovendien aan een aantal bijkomende eisen, waaronder permanente debietcontrole en stofarme lediging.

**H-klasse** stofzuigers (High risk) moeten gebruikt worden voor stoffen waarvan de max. blootstellingswaarde  $< 0,1 \text{ mg/m}^3$  bedraagt. Deze stofzuigers laten minder dan 0,005 % van het opgezogen stof door en moeten ook voldoen aan een aantal bijkomende eisen, zoals permanente debietcontrole en stofarme lediging.

Opgelet: stofzuigers zonder aanduiding van de stofklasse volgens EN60335-2-69 bieden geen enkele garantie op het vlak van persoonlijke veiligheid en zijn derhalve niet geschikt voor professioneel gebruik.

## ACCU STOFZUIGERS L-KLASSE XGT



VC007GL, VC006GM: dubbel filtersysteem met automatisch zelfreinigende filter, zonder zuigkrachtonderbreking



- Accu stofzuiger met hoge zuigkracht, vergelijkbaar met model op netstroom
- Stofklasse L, met HEPA-filter
- Nat en droog gebruik, uitgerust met waterniveausensor en waterafvoer
- Automatisch zelfreinigende filter met dubbel filtersysteem
- Inclusief slang 28 mm en 38 mm, gebogen buis en vloerzuigmond
- AWS: de stofzuiger kan automatisch aangestuurd worden door AWS-compatibele powertools

		VC007GLZ01
Spanning		72 V (80Vmax)
Bijgeleverde accu's		-
Lader		-
Kuipvolume		40 l
Type		nat/droog
Filterklasse		L (HEPA)
Max. debiet (38 mm slang)		3,7 m <sup>3</sup> /min
Max. debiet (28 mm slang)		2,0 m <sup>3</sup> /min
Max. onderdruk		180 mbar
Gewicht		18,3 - 20,7 kg
Prijs in €	excl. btw	
	incl. btw	

## ACCU STOFZUIGERS M-KLASSE XGT



De VG006GM heeft een instelling van de slangdiameter en waarschuwingszoemer voor te lage luchtstroom.



- Accu stofzuiger met hoge zuigkracht, vergelijkbaar met model op netstroom
- Stofklasse M
- Nat en droog gebruik, uitgerust met waterniveausensor en waterafvoer
- Automatisch zelfreinigende filter met dubbel filtersysteem
- Inclusief slang 28 mm en 38 mm, gebogen buis en vloerzuigmond
- AWS: de stofzuiger kan automatisch aangestuurd worden door AWS-compatibele powertools

		VC006GMZ01
Spanning		72 V (80Vmax)
Bijgeleverde accu's		-
Lader		-
Kuipvolume		40 l
Type		nat/droog
Filterklasse		M
Max. debiet (38 mm slang)		3,7 m <sup>3</sup> /min
Max. debiet (28 mm slang)		2,0 m <sup>3</sup> /min
Max. onderdruk		180 mbar
Gewicht		18,4 - 20,8 kg
Prijs in €	excl. btw	
	incl. btw	

STOFZUIGERS L-KLASSE

Klasse L  
VC2512L

Klasse L  
VC2000L

Klasse L  
VC3011L

Klasse L  
VC3012L

INCLUSIEF  
1 SET ACCESSOIRES



STOFZUIGERS L-, M- EN H-KLASSE

Klasse L  
VC2510LX1

Klasse L  
VC3210LX1

Klasse M  
VC3211MX1

Klasse H  
VC3211HX1

INCLUSIEF  
1 SET ACCESSOIRES



Automatische filterreiniging  
zonder zuigkrachtonderbreking.

Automatische filterreiniging  
zonder zuigkrachtonderbreking.

STOFZUIGERS L- EN M-KLASSE

Klasse M  
VC2211MX1

Klasse L  
VC4210LX

Klasse M  
VC4210MX

INCLUSIEF  
1 SET ACCESSOIRES



Automatische filterreiniging  
zonder zuigkrachtonderbreking.

Automatische filterreiniging  
zonder zuigkrachtonderbreking.

Automatische filterreiniging  
zonder zuigkrachtonderbreking.



	VC2000L	VC2012L	VC2512L	VC3011L	VC3012L	VC3012M	VC2211MX1
Nominaal vermogen	1000 W	1100 W	1100 W	1000 W	1200 W	1200 W	1050 W
Max. debiet	3,6 m³/min	3,6 m³/min	3,6 m³/min	3,6 m³/min	3,7 m³/min	3,7 m³/min	3,5 m³/min
Max. onderdruk	210 mbar	210 mbar	210 mbar	210 mbar	230 mbar	230 mbar	220 mbar
Bruto kuipvolume	20 l	19 l	23 l	30 l	30 l	30 l	22 l
Gewicht	7,5 kg	7,3 kg	6,3 kg	10,5 kg	10 kg	10 kg	16,3 kg
Prijs in €	excl. btw						
	incl. btw						

	VC2510LX1	VC3210LX1	VC3211MX1	VC3211HX1	VC4210LX	VC4210MX
Nominaal vermogen	1050 W	1050 W	1050 W	1050 W	1200 W	1200 W
Max. debiet	3,5 m³/min	3,5 m³/min	3,5 m³/min	3,5 m³/min	4,5 m³/min	4,5 m³/min
Max. onderdruk	220 mbar	220 mbar	220 mbar	220 mbar	250 mbar	250 mbar
Bruto kuipvolume	32 l	40 l	40 l	40 l	42 l	42 l
Gewicht	10,5 kg	14,5 kg	16,9 kg	16,9 kg	15 kg	15 kg
Prijs in €	excl. btw					
	incl. btw					



# Accuveegmachine 40Vmax VS001G

XGT  
40Vmax

BL  
MOTOR

XPT  
EXTREME PROTECTION TECHNOLOGY



Met de VS001G introduceert Makita een zeer veelzijdige accuveegmachine voor zowel binnen- als buitengebruik. De machine kan zowel fijn stof als ook grover vuil opvangen. Met een werkbreedte van 480 mm (650 mm met zijborstel) is deze efficiënt in te zetten in grotere ruimten en ook op verharde zones in open lucht, maar tegelijkertijd is de machine ook zeer wendbaar en compact.



## De krachtpatser die alles opruimt

- De 40Vmax technologie garandeert een hoog vermogen, compacte afmetingen en snelle laadtijden.
- De machine maakt gebruik van een BL motor voor de aandrijving van de hoofdborstels en de zijborstel, een BL motor voor het afzuigsysteem en een derde motor voor het elektrisch schoonmaken van de stofilter door vibratie.
- Twee borstels die tegen elkaar indraaien nemen zowel het fijnstof op als grover afval op zoals zelfs 500-ml PET flesjes.
- De zijborstel aan de rechtse kant laat toe tot tegen een wand aan te reinigen.
- Het afzuigsysteem met HEPA filter houdt fijnstof tegen.
- De hoogte van zowel de hoofdborstel als zijborstel kan zeer gemakkelijk met een draaiknop ingesteld worden, perfect aangepast aan elke toepassing.



## Perfekte controle

- Twee snelheden voor de hoofdborstels onderaan en zijborstel. De lage snelheid maakt de machine extra stil vergroot de autonomie.
- Afzonderlijk inschakelbare zijborstel.
- Afzonderlijk inschakelbare stofafzuiging.
- Activatie van de elektrische filterreiniging.
- Inschakelbare LED verlichting vooraan.

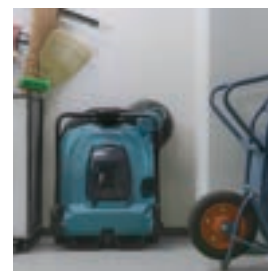

Werkt met één 40Vmax accu, het plaatsen van een tweede vergroot de autonomie. De overschakeling gebeurt automatisch.



Optioneel: multi-adaptor set (1913F5-2) voor het bevestigen van een MACPAC of PDC. De voeding via een PDC vergroot de autonomie.



Optioneel: opvangzak (1913F7-8) met capaciteit van 47 l, ideaal voor grover vuil dat veel plaats inneemt zoals bladeren.

## Gemakkelijk te transporteren en op te bergen

- Door het lage gewicht, de opvouwbare duwbeugel en de grote handgreep vooraan is de machine gemakkelijk te transporteren.
- Met een werkbreedte van 480 mm (650 mm met zijborstel) is de machine ook effectief in grotere ruimten maar kan bijvoorbeeld toch ook nog door een deur van 800 mm.
- De machine kan plaatsbesparend verticaal gestockeerd worden.

### VS001GZ

Spanning	36 V (40Vmax)
Werkbreedte	480 mm
Werkbreedte met zijborstel	650 mm
Capaciteit (stapsnelheid 4 km/u)	2600 m <sup>2</sup> /u
Inhoud standaard opvangbox	24 l
Inhoud opvangzak (optioneel)	47 l
Werktijd in vermogenstand 1-2 (accu 2x BL4080F)	480/200 min
Afmetingen (opgevouwen duwbeugel)	830 x 677 x 467 mm
Gewicht	29.9 - 33.1 kg

BOORHAMERS SDS-PLUS 2 FUNCTIES



	HR2600	HR1841FJ	HR2800
Nominaal vermogen	800 W	470 W	800 W
Slagenergie	2,4 J	1,4 J	2,8 J
Max. Ø beton	26 mm	18 mm	28 mm
AVT	-	✓	-
Vibratieniveau hamerboren	15,5 m/s <sup>2</sup>	7,5 m/s <sup>2</sup>	20 m/s <sup>2</sup>
Gewicht	2,8 kg	2,5 kg	3,4 kg
Prijs in €	excl. btw		
	incl. btw		

COMBIHAMERS SDS-PLUS 3 FUNCTIES



Inclusief automatische boorkop bij HR2630X7

Inclusief Boor- en beitelset 17 stuks bij HR2630TX12 & HR2631FT12 t.w.v.



	HR2470	HR2630X7	HR2630TX12	HR2631FT12	HR2811FT
Nominaal vermogen	780 W	800 W	800 W	800 W	800 W
Slagenergie	2,4 J	2,4 J	2,4 J	2,4 J	2,9 J
Max. Ø beton	24 mm	26 mm	26 mm	26 mm	28 mm
AVT	-	-	-	✓	-
Vibratieniveau hamerboren	15,5 m/s <sup>2</sup>	15 m/s <sup>2</sup>	15 m/s <sup>2</sup>	11,5 m/s <sup>2</sup>	15 m/s <sup>2</sup>
Verwisselbare boorkop	-	-	-	✓	✓
Gewicht	3,0 kg	3,0 kg	2,9 kg	3,0 kg	3,6 kg
Prijs in €	excl. btw				
	incl. btw				

COMBIHAMERS SDS-PLUS MET STOF AFZUIGING



Inclusief boor- en beitelset 17 stuks bij HR2651TX12 t.w.v.



Inclusief stofafzuigingsunit DX11 bij HR3012FCWJ



	HR2651TX12	HR3012FCWJ
Nominaal vermogen	800 W	1050 W
Slagenergie	2,2 J	3,9 J
Max. Ø beton	26 mm	30 mm
AVT	✓	✓
Vibratieniveau hamerboren	11,5 m/s <sup>2</sup>	9,5 m/s <sup>2</sup>
Gewicht	4,2 kg	4,4 kg
Prijs in €	excl. btw	
	incl. btw	

COMBIHAMERS SDS-PLUS



HR3210FCT

HR3210FCT:  
met anti-vibratie  
handgreep

**INCLUSIEF**  
1 automatische  
boorkop (194568-7)  
bij HR3210FCT



	HR3200C	HR3210FCT
Nominaal vermogen	850 W	850 W
Slagenergie	5,1 J	4,9 J
Max. Ø beton	32 mm	32 mm
AVT	-	✓
Vibratieniveau hamerboren	18 m/s <sup>2</sup>	10 m/s <sup>2</sup>
Gewicht	4,8 kg	5,4 kg
Prijs in €	excl. btw	
	incl. btw	

COMBIHAMERS SDS-MAX



gratis 5-delige  
boor- en beitelset  
P-52445 bij HR4013C, HR4511C  
en HR5212C  
t.w.v.



HR4013CV

CV-modellen  
inclusief  
stofafzuigset

	HR3541FCX	HR4013C	HR4013CV	HR4511C	HR4511CV	HR5212C
Nominaal vermogen	850 W	1100 W	1100 W	1350 W	1350 W	1500 W
Slagenergie	5,7 J	8,0 J	8,0 J	9,4 J	9,4 J	18,9 J
Max Ø beton	35 mm	40 mm	40 mm	45 mm	45 mm	52 mm
AVT	✓	✓	✓	✓	✓	✓
Vibratieniveau hamerboren	11 m/s <sup>2</sup>	5,0 m/s <sup>2</sup>	5,0 m/s <sup>2</sup>	7,5 m/s <sup>2</sup>	7,5 m/s <sup>2</sup>	12,5 m/s <sup>2</sup>
Gewicht	5,6 kg	6,8 kg	6,8 kg	8,8 kg	8,8 kg	12,1 kg
Prijs in €	excl. btw					
	incl. btw					

STOFZUIGSET VOOR BOOR-EN BREEKHAMERS

Hamerboren

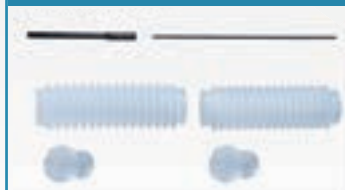

Beitelen



	199142-6	195866-2	196858-4
	HR4013C	HR4511C	HR5212C
Prijs in €	excl. btw		
	incl. btw		



BIKHAMERS SDS-PLUS



HK1820

	HK0500	HK1820
Nominaal vermogen	550 W	550 W
Slagfrequentie	2000-3500 /min	0-3200 /min
Slagenergie	1,8 J	3,1 J
AVT	-	-
Triaxiale vibratiewaarde (ah)	9,5 m/s <sup>2</sup>	10 m/s <sup>2</sup>
Gewicht	3,2 kg	3,4 kg
Prijs in €	excl. btw	
	incl. btw	

BREEKHAMERS SDS-MAX



HM1213C

**PROMO**  
gratis 5-delige  
beitelset  
E-20236 bij  
HM0871C

Wist u dat u tijdens de garantieperiode recht hebt op één gratis onderhoudsbeurt? Ontdek er meer over op [www.makita.be](http://www.makita.be)



**SOFT NOLOAD**



HM0871C



HM1214C

**CV-modellen**  
inclusief  
stofafzuigset

	HM0870C	HM0871C	HM1101C	HM1101CV
Nominaal vermogen	1100 W	1100 W	1300 W	1300 W
Slagfrequentie	1100-2650 /min	1100-2650 /min	1100-2600 /min	1100-2600 /min
Slagenergie	7,6 J	8,1 J	11,5 J	11,5 J
AVT	-	✓	-	-
Triax. vibratie beitelen (ah)	11,5 m/s <sup>2</sup>	8 m/s <sup>2</sup>	13,5 m/s <sup>2</sup>	13,5 m/s <sup>2</sup>
Gewicht	5,1 kg	5,8 kg	7 kg	7 kg
Prijs in €	excl. btw			
	incl. btw			

	HM1111C	HM1203C	HM1213C	HM1214C
Nominaal vermogen	1300 W	1510 W	1510 W	1510 W
Slagfrequentie	1100-2600 /min	950-1900 /min	950-1900 /min	950-1900 /min
Slagenergie	11,2 J	19,1 J	18,6 J	19,9 J
AVT	✓	-	✓	✓
Triax. vibratie beitelen (ah)	8 m/s <sup>2</sup>	15,5 m/s <sup>2</sup>	7 m/s <sup>2</sup>	8 m/s <sup>2</sup>
Gewicht	7,7 kg	9,7 kg	10,8 kg	12,3 kg
Prijs in €	excl. btw			
	incl. btw			

STOFAFZUIGING BREEKHAMERS



199144-2



197168-2

		199144-2	197168-2
Geschikt voor		Breekhamers SDS-Max	HM1812 / HM1317C
Prijs in €	excl. btw		
	incl. btw		

**SOFT  
NO LOAD**

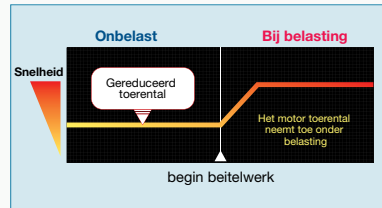

Reduceert automatisch het toerental van de machine om ongewenste trillingen verder te reduceren.

BREEKHAMERS MET ZESKANTOPNAME



**SOFT  
NO LOAD** **AVT**  
ANTI VIBRATION TECHNOLOGY

**HM1511/HM1512:**  
slagenergie  
48,9 J



HM1812

GRATIS  
trolley D-54972  
bij HM1812



**HM1812:**  
slagenergie 72,8 J



HM1511

**HM1511 / HM1512 :**  
Uitzonderlijk laag trillings-  
niveau door anti-vibratie behuizing,  
actieve trillingsdemping en de  
soft-no-load regeling



	HM1317C	HM1511	HM1512	HM1812
Nominaal vermogen	1510 W	1850 W	1850 W	2000 W
Slagfrequentie	730-1450 /min	1300 /min	1300 /min	870 /min
Slagenergie	25 J	48,9 J	48,9 J	72,8 J
AVT	✓	✓	✓	✓
Triax. vibratie beitelen (ah)	8,5 m/s <sup>2</sup>	6,5 m/s <sup>2</sup>	6,5 m/s <sup>2</sup>	6,5 m/s <sup>2</sup>
Opname hex.	30 mm	30 mm	28,6 mm	28,6 mm
Gewicht	17 kg	19,2 kg	20,4 kg	31,3 kg
Prijs in €	excl. btw			
	incl. btw			

# DP4021

- Met variabele snelheidsregeling, voor- en achteruit
- Hoog vermogen dankzij verbeterde motor met grotere lengte
- Stabiele lagering van de boorkop
- Ideaal voor het boren in metaal
- Zeer compacte machine met een kleine greepontrek
- Variabel toerental en omkeerschakelaar

## KLOPBOORMACHINES



HP2071FJ

HP1631KSP HP2051FHJ HP2071FJ

	HP1631KSP	HP2051FHJ	HP2071FJ
Nominaal vermogen	710 W	720 W	1010 W
Toerental	0-3200 t.p.m.	0-2900 t.p.m.	0-2900 t.p.m.
Ø Max. staal	13 mm	13 mm	18 mm
Ø Max. hout	30 mm	40 mm	40 mm
Ø Max. steen	16 mm	20 mm	20 mm
Boorkop	1,5-13 mm	1,5-13 mm	1,5-13 mm
Makpac	-	✓	✓
Gewicht	2 kg	2,5 kg	2,6 kg
Prijs in €	excl. btw		
	incl. btw		

## BOORMACHINES



DP4011  
Met 2 snelheden

NIEUW

	DP2011	DP4003	DP4011	DP4021
Nominaal vermogen	370 W	750 W	720 W	630 W
Toerental	0-4200 t.p.m.	0-700 t.p.m.	0-2900 t.p.m.	0 - 3000 t.p.m.
Ø Max. staal	6,5 mm	13 mm	13 mm	13 mm
Ø Max. hout	15 mm	38 mm	40 mm	30 mm
Boorkop	0,8-6,5 mm	1,5-13 mm	1,5-13 mm	1,5-13 mm
Gewicht	1,1 kg	2,4 kg	2,3 kg	1,6 kg
Prijs in €	excl. btw			
	incl. btw			

## DIAMANTKERNBOORMACHINES



DBM131W

DBM131W / DBM230W  
Geleverd met boorstandaard



	DBM131	DBM131W	DBM230W
Nominaal vermogen	1700 W	1700 W	2500 W
Toerental onbelast 1	1100 t.p.m.	1100 t.p.m.	390 t.p.m.
Toerental onbelast 2	2300 t.p.m.	2300 t.p.m.	1040 t.p.m.
Toerental onbelast 3	-	-	1700 t.p.m.
Opname	M18	M18	1-1/4"UNC
Ø Max. beton	132 mm	132 mm	230 mm
Gewicht	6,1 kg	6,1 kg	6,9 kg
Prijs in €	excl. btw		
	incl. btw		

## ACCESSOIRES



### Diamantboren

Nieuwe beton diamantkernboren voor nat gebruik.

- Langere levensduur dankzij lasergelaste segmenten.
- Totale lengte verhoogd naar 450mm.
- Snellere boorprestatie dankzij chevron-vormige diamantdeeltjes.

Omschrijving	Best. nr.	Ø	Lengte	Opname	Stuks	Prijs excl. btw	Prijs incl. btw
Diamantkernboor	E-19869	32 mm	450 mm	1-1/4"UNC	1		
Diamantkernboor	E-19875	42 mm	450 mm	1-1/4"UNC	1		
Diamantkernboor	E-19881	52 mm	450 mm	1-1/4"UNC	1		
Diamantkernboor	E-19897	62 mm	450 mm	1-1/4"UNC	1		
Diamantkernboor	E-19906	68 mm	450 mm	1-1/4"UNC	1		
Diamantkernboor	E-19912	72 mm	450 mm	1-1/4"UNC	1		
Diamantkernboor	E-19928	82 mm	450 mm	1-1/4"UNC	1		
Diamantkernboor	E-19934	92 mm	450 mm	1-1/4"UNC	1		
Diamantkernboor	E-19940	102 mm	450 mm	1-1/4"UNC	1		
Diamantkernboor	E-19956	107 mm	450 mm	1-1/4"UNC	1		
Diamantkernboor	E-19962	112 mm	450 mm	1-1/4"UNC	1		

Omschrijving	Best. nr.	Ø	Lengte	Opname	Stuks	Prijs excl. btw	Prijs incl. btw
Diamantkernboor	E-19978	117 mm	450 mm	1-1/4"UNC	1		
Diamantkernboor	E-19984	122 mm	450 mm	1-1/4"UNC	1		
Diamantkernboor	E-19990	127 mm	450 mm	1-1/4"UNC	1		
Diamantkernboor	E-20002	132 mm	450 mm	1-1/4"UNC	1		
Diamantkernboor	E-20018	142 mm	450 mm	1-1/4"UNC	1		
Diamantkernboor	E-20024	152 mm	450 mm	1-1/4"UNC	1		
Diamantkernboor	E-20030	162 mm	450 mm	1-1/4"UNC	1		
Diamantkernboor	E-20046	172 mm	450 mm	1-1/4"UNC	1		
Diamantkernboor	E-20052	182 mm	450 mm	1-1/4"UNC	1		
Diamantkernboor	E-20068	202 mm	450 mm	1-1/4"UNC	1		
Diamantkernboor	E-20074	212 mm	450 mm	1-1/4"UNC	1		



P-42151

ADAPTER M18 NAAR 1-1/4" UNC  
EXCL. BTW:



HAAKSE BOORMACHINES



DA3010FJ

		DA3010FJ
Nominaal vermogen		450 W
Toerental		0-2400 t.p.m.
Ø Max. staal		10 mm
Ø Max. hout		25 mm
Boorkop		1-10 mm
Gewicht		1,6 kg
Prijs in €	excl. btw	
	incl. btw	

KERNBOORMACHINE MET MAGNEETVOET



		HB350	HB500
Nominaal vermogen		1050 W	1150 W
Toerental onbelast 1		450 t.p.m.	350 t.p.m.
Toerental onbelast 2		850 t.p.m.	650 t.p.m.
Ø Max. staal		35 mm	50 mm
Klemkracht magneetvoet		8000 N	9300 N
Opname		3/4" WELDON	3/4" WELDON
Gewicht		11,5 kg	18,5 kg
Prijs in €	excl. btw		
	incl. btw		

MENGRS



UT1600

		UT1400	UT1401	UT1600
Nominaal vermogen		1150 W	1150 W	1600 W
Toerental onbelast 1		0-900 t.p.m.	0-400 t.p.m.	0-440 t.p.m.
Toerental onbelast 2		-	0-730 t.p.m.	0-970 t.p.m.
Toerental belast max.		0-580 t.p.m.	0-450 t.p.m.	0-580 t.p.m.
Schroefdraad spindel		M14	M14	M14
Gewicht		5,2 kg	5,5 kg	7,1 kg
Prijs in €	excl. btw			
	incl. btw			

BOORMACHINE / MENGERS



		DS4012
Nominaal vermogen		750 W
Toerental		600 t.p.m.
Ø Max. staal		13 mm
Ø Max. hout		36 mm
Boorkop		2-13 mm
Gewicht		2,8 kg
Prijs in €	excl. btw	
	incl. btw	

SCHROEFAUTOMATEN



6843J

		6844	6843J
Nominaal vermogen		470 W	470 W
Toerental		3000 t.p.m.	6000 t.p.m.
Ø gipsplaat Schroef		3,5 - 4,0 mm	3,5 - 4,0 mm
Schroeflengte		45-75 mm	25-55 mm
Verpakking		Koffer	Makpac
Gewicht		2 kg	2 kg
Prijs in €	excl. btw		
	incl. btw		

SCHROEFMACHINES VOOR GIPSPLAAT



FS2500K: met 1/4" Hex bitopname



FS2500



FS2701K

FS2701K: met koppelingstelling (6 stappen)



schroeflintadapter 191L24-0

		FS2300K	FS2500K	FS2701K	FS4000JX2	FS6300RJX2
Nominaal vermogen		570 W	570 W	570 W	570 W	570 W
Toerental		0-2500 t.p.m	0-2500 t.p.m	0-2500 t.p.m	0-4000 t.p.m.	0-6000 t.p.m.
Ø gipsplaat Schroef		5 mm	5 mm	5 mm	5 mm	5 mm
Incl. schroeflintadapter		-	-	-	✓	✓
Gewicht		1,7 kg	1,6 kg	1,7 kg	1,3 kg	1,4 kg
Prijs in €	excl. btw					
	incl. btw					

COMFORTABEL WERKEN MET SUPER JOINT SYSTEM II

**Zonder SJS**







Bladveer absorbeert trillingen en vermindert schokken tijdens het werken

HAAKSE SLIJPER 125 MM





GA5030RSP2

		GA5034	GA5030RK	GA5030RSP2
Nominaal vermogen		720 W	720 W	720 W
Toerental		11000 t.p.m.	11000 t.p.m.	11000 t.p.m.
Ø schijf		125 mm	125 mm	125 mm
Dodemansschakelaar		✓	-	-
Gewicht		1,9 kg	1,8 kg	1,8 kg
Prijs in €	excl. btw			
	incl. btw			

HAAKSE SLIJPER 115 MM



GA4530RK

		GA4530RK
Nominaal vermogen		720 W
Toerental		11000 t.p.m.
Ø schijf		115 mm
Gewicht		1,8 kg
Prijs in €	excl. btw	
	incl. btw	

HAAKSE SLIJPER 125 MM



9558HNRGK3:

geleverd met  
1 afbraamschijf en  
2 diamantschijven

125 MM

**NIEUW**

		9558HNRGZ	9558HPGY	9558HNRGK3
Nominaal vermogen		840 W	840 W	840 W
Toerental		11000 t.p.m.	11000 t.p.m.	11000 t.p.m.
Ø schijf		125 mm	125 mm	125 mm
Dodemansschakelaar		-	✓	-
Gewicht		2,1 kg	2,1 kg	2,1 kg
Prijs in €	excl. btw			
	incl. btw			



**9558HPGY is uitgerust met een dodemansschakelaar: de motor schakelt uit bij loslaten van schakelaar voor verhoogde veiligheid.**

HAAKSE SLIJPER 125 MM X-LOCK



Snel en veilig schijven bevestigen via een kliksysteem.



GA5080RX03

GA5080RX03

Nominaal vermogen	1400 W
Toerental	12000 t.p.m.
Ø schijf	125 mm
Verpakking	Makpac
Gewicht	2,5 – 3,6 kg
Prijs in €	excl. btw
	incl. btw

HAAKSE SLIJPERS 125 MM



GA5041CT01

GA5040CJD1



GA5041CT01 met mechanische motorrem, instelbaar toerental, Ezynut & AVT-grip

SA5040C Traagdraaiend

	GA5040RZ	GA5040RKDJ	GA5040C	GA5040CJD	GA5040CJD1	GA5041RZ	GA5041CT01	SA5040C
Nominaal vermogen	1100 W	1100 W	1400 W	1400 W	1400 W	1100 W	1400 W	1400 W
Toerental	11000 t.p.m.	11000 t.p.m.	2800-11000 t.p.m.	2800-11000 t.p.m.	2800-11000 t.p.m.	11000 t.p.m.	2700-11000 t.p.m.	2000-7800 t.p.m.
Heropstartbeveiliging	✓	✓	✓	✓	✓	✓	✓	✓
Mechanische rem	-	-	-	-	-	✓	✓	-
Type schakelaar	Schuifschakelaar met vergrendeling	Schuifschakelaar met vergrendeling	Schuifschakelaar met vergrendeling	Schuifschakelaar met vergrendeling	Schuifschakelaar met vergrendeling	Schuifschakelaar met vergrendeling	Schuifschakelaar met vergrendeling	Schuifschakelaar met vergrendeling
Verpakking	Karton	Makpac	Karton	Makpac	Makpac	Karton	Karton	Karton
Gewicht	2,4 kg	2,4 kg	2,4 kg	2,4 kg	2,7 kg	2,4 kg	2,7 kg	2,2 kg
Meegeleverde accessoires	-	2 x diamantschijf	-	2 x diamantschijf	1 x diamantschijf + beschermkap stofafzuiging	-	AVT-greep + Ezynut sluitmoer	-
Prijs in €	excl. btw							
	incl. btw							

HAAKSE SLIJPERS 125 MM / 150 MM



9565PCV01

9565PCV01 & 9566PCV01: Antivibratiehandgreep en dodemansschakelaar.



GA5050R: grote lepelschakelaar + gereedschapsloze beschermkap

	GA5050R	9565CRX1	9565PCV01	GA6040C	9565HRZ	9565CVR
Nominaal vermogen	1300 W	1400 W	1400 W	1400 W	1100 W	1400 W
Toerental	11000 t.p.m.	11000 t.p.m.	2800-11500 t.p.m.	4000-9000 t.p.m.	12000 t.p.m.	2800 - 12000 t.p.m.
SJS	-	✓	✓	✓	✓	✓
Ø schijf	125 mm	125 mm	125 mm	150 mm	125 mm	125 mm
Type schakelaar	Lepelschakelaar zonder vergrendeling	Schuifschakelaar met vergrendeling	Lepelschakelaar zonder vergrendeling	Schuifschakelaar met vergrendeling	Schuifschakelaar met vergrendeling	Schuifschakelaar met vergrendeling
Heropstartbeveiliging	✓	✓	-	✓	✓	✓
Gewicht	2,5 kg	2,6 kg	2,6 kg	2,6 kg	2,3 kg	2,3 kg
Prijs in €	excl. btw					
	incl. btw					

HAAKSE SLIJPERS 125 MM



GA5021CY

GA5021CYX1: Inclusief antivibratiegreep en Ezynut sluitmoer

	GA5021C	GA5021CY	GA5021CYX1
Nominaal vermogen	1450 W	1450 W	1450 W
Toerental	10000 t.p.m.	10000 t.p.m.	10000 t.p.m.
Ø schijf	125 mm	125 mm	125 mm
Dodemansschakelaar	-	✓	✓
Gewicht	3 kg	3 kg	3 kg
Prijs in €	excl. btw		
	incl. btw		

10x Doorslijpschijven in blik



Ref.	Ø (mm)	Dikte (mm)	Ø asgat (mm)	Prijs	
				excl. btw	incl. btw
D-18770-10	125	1,2	22,23		



HAAKSE SLIJPERS 125 MM

- Bestand tegen langdurige hoge belasting dankzij verbeterde koeling
- Greepomtrek van slechts 205 mm
- Mechanische rem (GA5091, GA5093, GA5094)
- De AFT functie stopt de motor ogenblikkelijk wanneer de schijf blokkeert



**PROMO**

gratis snelsluitmoer EZYNUT 195354-9

	GA5092X01	GA5090X01	GA5091X01	GA5095X01	GA5094	GA5093X01
Nominaal vermogen	1900 W	1900 W	1900 W	1900 W	1900 W	1900 W
Toerental	11500 min <sup>-1</sup>	2800-11500 min <sup>-1</sup>	2800-11500 min <sup>-1</sup>	11500 min <sup>-1</sup>	11500 min <sup>-1</sup>	2800-11500 min <sup>-1</sup>
Variabel toerental	-	✓	✓	-	-	✓
Mechanische rem	-	-	✓	-	✓	✓
Type Schakelaar	Schuifschakelaar	Schuifschakelaar	Schuifschakelaar	Lepelschakelaar	Lepelschakelaar	Lepelschakelaar
Dodemansschakelaar	-	-	-	✓	✓	✓
Gewicht	2,6 - 3,8 kg	2,6 - 3,8 kg	2,8 - 4,0 kg	2,7 - 3,8 kg	2,9 - 4,0 kg	2,9 - 4,0 kg
Prijs in €	excl. btw					
	incl. btw					

ACCESSOIRES

	Omschrijving	Artikel	Diameter	Dikte	Asgat	Reductiering	Specificatie	Hoogte segment	Verpakkings-eenheid	Prijs excl. btw	Prijs incl. btw
	Doorslijpschijf staal	P-53023	125 mm	1,0 mm	22,23 mm		A60R-BF		1		
	Doorslijpschijf inox	P-53045	125 mm	1,0 mm	22,23 mm		A60S-BF		1		
	Doorslijpschijf inox 'Fast cutting'	B-45733	125 mm	0,8 mm	22,23 mm		Z60T-BF		1		
	Doorslijpschijf inox 'Fast cutting'	B-45733-12	125 mm	0,8 mm	22,23 mm		Z60T-BF		12		
	Diamantschijf Comet	B-12778	125 mm	2,0 mm	22,23 mm	20 mm		10 mm	1		
	Doorslijpschijf staal	P-05773	230 mm	2,5 mm	22,23 mm		A30S4-BF		1		
	Doorslijpschijf inox	E-13764	230 mm	1,9 mm	22,23 mm		A60U-BF		1		
	Diamantschijf Nebula	B-54025	230 mm	2,4 mm	22,23 mm	20 mm		10 mm	1		

BORSTELS VOOR SLIJPERS

**NIEUW**

	Artikel	Diameter	Draaddikte	Draadtype	Opname	Toepassing	Prijs excl. btw	Prijs incl. btw
	D-77453	75	0,3 mm	RVS, gegolfd	M14	Ruwe oppervlakte		
	D-77497	75	0,3 mm	RVS, geknoopt	M14	Ruwe oppervlakte, snel		
	D-77512	115	0,3 mm	RVS, gegolfd	M14	Plaatselijke behandeling, recht		
	D-77562	115	0,3 mm	RVS, gegolfd	M14	Plaatselijke behandeling, gebogen		
	D-77534	115	0,3 mm	RVS, geknoopt	M14	Hoeken, recht		
	D-77584	115	0,3 mm	RVS, geknoopt	M14	Hoeken, gebogen		

HAAKSE SLIJPERS 180 MM



GA7082

GA7070X1

	GA7050	GA7082	GA7070X1	GA7070YX1
Nominaal vermogen	2000 W	2800 W	2800 W	2800 W
Toerental	8500 t.p.m.	8500 t.p.m.	8500 t.p.m.	8500 t.p.m.
Dodemansschakelaar	✓	-	-	✓
Draibare achterhandgreep	-	-	✓	✓
Mechanische rem	-	-	✓	✓
Gewicht	4,5 kg	6,0 kg	6,2 - 6,7 kg	6,1 - 6,6 kg
Prijs in €	excl. btw			
	incl. btw			

HAAKSE SLIJPERS 230 MM



GA9061R



GA9082



GA9060KD

Incl. diamantschijf

	GA9050	GA9060	GA9060KD	GA9082	GA9061R
Nominaal vermogen	2000 W	2200 W	2200 W	2700 W	2200 W
Toerental	6600 t.p.m.	6600 t.p.m.	6600 t.p.m.	6600 t.p.m.	6600 t.p.m.
Soft start	-	-	-	✓	✓
Dodemansschakelaar	✓	✓	✓	-	-
Draibare achterhandgreep	-	-	-	-	-
Heropstartbeveiliging	-	-	-	-	✓
Gewicht	4,7 kg	5,6 kg	5,6 kg	6,1 kg	5,7 kg
Prijs in €	excl. btw				
	incl. btw				

HAAKSE SLIJPERS 230 MM



GA9040RF01



GA9030SF01



GA9070YX1



GA9071YX1:  
Met gesloten handgreep

	GA9030SF01	GA9030RF01	GA9040SF01	GA9040RF01	GA9080X1	GA9070X1	GA9070YX1	GA9071X1	GA9071YX1
Nominaal vermogen	2400 W	2400 W	2600 W	2600 W	2700 W	2800 W	2800 W	2800 W	2800 W
Toerental	6600 t.p.m.	6600 t.p.m.	6600 t.p.m.	6600 t.p.m.	6600 t.p.m.	6600 t.p.m.	6600 t.p.m.	6600 t.p.m.	6600 t.p.m.
Dodemansschakelaar	✓	-	✓	-	-	-	✓	-	✓
Draibare achterhandgreep	✓	✓	✓	✓	✓	✓	✓	✓	✓
Antivibratie zijhandgreep	✓	✓	✓	✓	-	✓	✓	✓	✓
Soft start	✓	✓	✓	✓	✓	✓	✓	✓	✓
Heropstartbeveiliging	-	✓	-	✓	✓	✓	✓	✓	✓
Mechanische rem	-	-	-	-	-	✓	✓	✓	✓
Gewicht	6,3 kg	6,5 kg	6,7 kg	6,9 kg	6,4 kg	6,3 kg	6,3 - 8,5 kg	6,4 kg	6,3 - 8,5 kg
Prijs in €	excl. btw								
	incl. btw								

STEMPELSLIJERS



	GD0600	GD0603	GD0800C	GD0810C	GD0801C	GD0811C	GS5000
Nominaal vermogen	400 W	240 W	750 W	750 W	750 W	750 W	750 W
Toerental	25000 t.p.m.	28000 t.p.m.	7000-28000 t.p.m.	1800-7000 t.p.m.	7000-28000 t.p.m.	1800-7000 t.p.m.	5600 t.p.m.
Ø spantang - bereik	6 mm	6 mm	6-8 mm	6-8 mm	6-8 mm	6-8 mm	20 mm
Ø spantang - inbegrepen	6 mm	6 mm	6 mm	6 mm	6 mm	6 mm	20 mm
Lepelschakelaar	✓	-	-	-	✓	✓	-
Dodemans	-	-	-	-	✓	✓	✓
Gewicht	1,7 kg	0,97 kg	1,7 kg	1,7 kg	1,7 kg	2,0 kg	5,0 kg
Prijs in €	excl. btw						
	incl. btw						



COMBOPACK SLIJERS



GA9060 125 mm  
230 mm

		DK0047GX1
Haakse slijper 230 mm		GA9060
Haakse slijper 125 mm		9558HNRG
Diamantschijf		2 x Diamak DS
Synthetische koffer		✓
Prijs in €	excl. btw	
	incl. btw	

COMBOPACK SCHUURMACHINE + STOFZUIGER

		DK6525
Schuurmachine		BO6050J
Stofzuiger		VC2510LX1
Prijs in €	excl. btw	
	incl. btw	



METAALAFKORTMACHINES

**LC1230N**

- Inclusief HM zaagblad
- verstekhoek instelbaar op 45°



LW1400X



LC1230N

	LW1400X	LC1230N
Nominaal vermogen	2200 W	1750 W
Type schijf	doorslijpschijf	zaagblad
Toerental	3800 t.p.m.	1300 t.p.m.
Zaagdiepte (90°)	115 mm	100 mm
Ø Zaagblad	355 mm	305 mm
Gewicht	17,2 kg	19,3 kg
Prijs in €	excl. btw	
	incl. btw	

BETONSCHAVEN

PC5001C  
Geleverd met  
komschijf  
B-12289



PC50001C

PC5010C

**PC5010C:**  
Instelbaar toerental

	PC5010C	PC5001C
Nominaal vermogen	1400 W	1400 W
Ø schijf	125 mm	125 mm
Gewicht	2,5 kg	5,1 kg
Prijs in €	excl. btw	
	incl. btw	

MUURFREZEN



SG150



SG181

	SG1251J	SG150	SG181
Nominaal vermogen	1400 W	1800 W	2150 W
Max. slijpdiepte	30 mm	45 mm	60 mm
Sleufbreedte	6-30 mm	7-35 mm	7-43 mm
Ø schijf	125 mm	150 mm	180 mm
Gewicht	4,4 kg	5,7 kg	6 kg
Prijs in €	excl. btw		
	incl. btw		

DIAMANTZAAG



**4114S**

Nominaal vermogen	2400 W
Max. slijpdiepte	125 mm
Ø schijf	350 mm
Ø asgat	25,4 mm
Gewicht	10,8 kg
Prijs in €	excl. btw
	incl. btw

DIAMANTZAAG



**4100KB**

Nominaal vermogen	1400 W
Zaagdiepte (90°)	40 mm
Ø Zaagblad	125 mm
Gewicht	3,0 kg
Prijs in €	excl. btw
	incl. btw

SLAGMOERSLEUTELS



TW0200J  
TW0350J  
6906J

TW0350J

	TW0200J	TW0350J	6906J	TW1000
Nominaal vermogen	380 W	400 W	650 W	1300 W
Max. koppel	200 Nm	350 Nm	588 Nm	1000 Nm
Bitopname	1/2" vierkant	1/2" vierkant	3/4" vierkant	1" vierkant
Gewicht	2,2 kg	3 kg	5,6 kg	8,6 kg
Prijs in €	excl. btw			
	incl. btw			

HETELUCHTPISTOLEN



HG6531CK



HG5030K

	HG5030K	HG6031VK	HG6531CK
Vermogen	1600 W	1800 W	2000 W
Temperatuurbereik	350-500 °C	50-600 °C	50-650 °C
Temperatuurstelling	2 niveaus	9 niveaus	Elektronisch in stappen van 5°C
Debiet	300 / 500 l/min	250 / 500 l/min	200 / 550 l/min
Gewicht	0,56 kg	0,67 kg	0,71 kg
Prijs in €	excl. btw		
	incl. btw		

KNABBELSCHAREN



JN3201J

	JN1601	JN3201J
Nominaal vermogen	550 W	710 W
Max. dikte staal	1,6 mm	3,2 mm
Gewicht	1,6 kg	3,4 kg
Prijs in €	excl. btw	
	incl. btw	

PLAATSCHAREN



JS1602J

	JS1601J	JS1602J	JS3201J
Nominaal vermogen	380 W	380 W	710 W
Aantal zaagbewegingen	4500 /min	4000 /min	1600 /min
Max. dikte staal	1,6 mm	1,6 mm	3,2 mm
Gewicht	1,4 kg	1,6 kg	3,4 kg
Prijs in €	excl. btw		
	incl. btw		

METAALCIRKELZAAG



4131

Nominaal vermogen	1100 W
Toerental	3500 t.p.m.
Zaagdiepte (90°)	63 mm
Ø Zaagblad	185 mm
Gewicht	5,1 kg
Prijs in €	excl. btw
	incl. btw

GROEFFREES



CA5000XJ

Nominaal vermogen	1300 W
Toerental	2200-6400 t.p.m.
Ø Zaagblad	118 mm
Gewicht	5,1 kg
Prijs in €	excl. btw
	incl. btw

SLIJPMOLENS



GB801

	GB602W	GB801
Nominaal vermogen	250 W	550 W
Toerental	2850 t.p.m.	2850 t.p.m.
Ø Slijpsteen	150 mm	205 mm
Gewicht	9 kg	19,8 kg
Prijs in €	excl. btw	
	incl. btw	

LINTZAAGMACHINE

B-42581  
Schuurbanden 20 x 2240 mm  
Rood • Korrel 80

B-42597  
Schuurbanden 20 x 2240 mm  
Rood • Korrel 120

JM21000330  
Adapterset voor schuurbanden



	LB1200F
Nominaal vermogen	900 W
Breedte zaaglint	6-16 mm
Gewicht	81,2 kg
Prijs in €	excl. btw
	incl. btw

RECIPROZAGEN



JR3070CT

		JR3051TK	JR3061T	JR3070CT
Nominaal vermogen		1200 W	1250 W	1510 W
Aantal zaagbewegingen		0-3000 /min	0-2800 /min	0-2800 /min
AVT		-	-	✓
Pendelinstelling		-	-	✓
Slaglengthe		30 mm	32 mm	32 mm
Vibratieniveau		19,5 m/s <sup>2</sup>	23,5 m/s <sup>2</sup>	8,5 m/s <sup>2</sup>
Gewicht		3,2 kg	4,4 kg	4,4 kg
Prijs in €	excl. btw			
	incl. btw			

LAMELLENFREES



Revolver diepte-instelling met 6 preselecties voor een snelle afstelling.

Aanslagplaat met tandheugelverstelling voor een snelle en precieze aanpassing aan de materiaaldikte.

Kantelbare voetplaat met handige vergrendelingshendel en automatische stops op 0°, 45° en 90°.

		PJ7000J
Nominaal vermogen		700 W
Toerental		11000 t.p.m.
Ø zaagblad		100 mm
Asgat		22 mm
Gewicht		2,5 kg
Prijs in €	excl. btw	
	incl. btw	

MULTITOOL



INCLUSIEF:  
Set van 9 accessoires,  
30 schuurvellen en 1 afzuigset



GEREEDSCHAPSLOZE  
ACCESSOIREWISSEL

		TM3010CX3J
Nominaal vermogen		320 W
Oscillatiefrequentie		6000-20000/min
Oscillatiehoek		3,2°
Gewicht		1,6 kg
Prijs in €	excl. btw	
	incl. btw	

VANDIKTEBANK



		2012NB
Nominaal vermogen		1650 W
Toerental		8500 t.p.m.
Breedte		304 mm
Max. doorlaathoogte		155 mm
Max. spaanafname		3 mm
Gewicht		28,1 kg
Prijs in €	excl. btw	
	incl. btw	

KETTINGFREZEN



		7104L	7104L-30
Nominaal vermogen		1140 W	1140 W
Toerental		3200 t.p.m.	3200 t.p.m.
Kettingsnelheid onbelast		5 m/s	5 m/s
Ketting		16,5 mm	30 mm
Gatbreedte		16,5-30 mm	30-45 mm
Gatlengthe		54-130 mm	54-130 mm
Gewicht		17,3 kg	17,3 kg
Prijs in €	excl. btw		
	incl. btw		



BOVENFREZEN



RP1111CJ



RP2302FC07

RP2302FC07: Inclusief langsgleider met fijnafstelling

	RP0900J	RP1111CJ	RP1802FX02	RP2302FC07
Nominaal vermogen	900 W	1100 W	1850 W	2300 W
Toerental	27000 t.p.m.	8000 - 27500 t.p.m.	23000 t.p.m.	9000-22000 t.p.m.
Max. induikdiepte	35 mm	57 mm	70 mm	70 mm
Ø Spantang - bereik	6-8 mm	6-8 mm	6-12 mm	6-12 mm
Ø Spantang - inbegrepen	8 mm	8 mm	6, 8, 12 mm	6, 8, 12 mm
Verpakking	Makpac	Makpac	Karton	Makpac
Gewicht	2,7 kg	3,3 kg	6,2 kg	6,1 kg
Prijs in €	excl. btw			
	incl. btw			

KANTENFREZEN



3711



3712

3712: Inclusief kantelbare zool

	3711	3712
Nominaal vermogen	530 W	530 W
Toerental	32000 t.p.m.	32000 t.p.m.
Max. induikdiepte	42 mm	42 mm
Spantang	6 mm	6 mm
Gewicht	1,5 kg	1,7 kg
Prijs in €	excl. btw	
	incl. btw	

BOVEN- EN KANTENFREES



4 MACHINES IN 1

- Rechte kantenrees
- Verstelbare kantenrees
- Kantenrees met verschoven spindel
- Bovenrees

Rechte kantenrees  
Regelbare freesdiepte van 0 tot 40 mm

Verstelbare kantenrees  
Hoekinstelling tussen -30° en 45°

Kantenrees met verschoven spindel om zo dicht mogelijk tegen een obstakel te werken

Bovenrees  
Diepteregeling per 1/10 van een mm van 0 tot 35 mm

RT0702CX3J

Nominaal vermogen	710 W
Toerental	10000-30000 t.p.m.
Max. induikdiepte	35 mm
Ø Spantang - bereik	6 - 8 mm
Ø Spantang - inbegrepen	6 mm, 8 mm
Gewicht	1,8 kg
Prijs in €	excl. btw
	incl. btw

SCHAVEN



KP0810CJ

	KP0800J	KP0810J	KP0810CJ	1100	1911BJ	1806B	KP312S
Nominaal vermogen	620 W	850 W	1050 W	950 W	900 W	1200 W	2200 W
Toerental	17000 t.p.m.	16000 t.p.m.	12000 t.p.m.	16000 t.p.m.	16000 t.p.m.	18000 t.p.m.	12000 t.p.m.
Breedte	82 mm	82 mm	82 mm	82 mm	110 mm	170 mm	312 mm
Max. spaanafname	2,5 mm	4 mm	4 mm	3 mm	2 mm	2 mm	3,5 mm
Gewicht	2,6 kg	3,3 kg	3,4 kg	5,1 kg	4,3 kg	9,0 kg	18,4 kg
Prijs in €	excl. btw						
	incl. btw						

DECOUPEERZAGEN



4350FCTJ



4351FCTJ



JV0600J



4329K



	4326	4329K	JV0600J	4350FCTJ	4351FCTJ
Nominaal vermogen	450 W	450 W	650 W	720 W	720 W
Aantal zaagbewegingen	3100 /min	500-3100 /min	500-3100 /min	800-2800 /min	800-2800 /min
Max. capaciteit hout	65 mm	65 mm	90 mm	135 mm	135 mm
Makpac	-	-	✓	✓	✓
Gewicht	1,8 kg	1,9 kg	2,4 kg	2,6 kg	2,5 kg
Prijs in €	excl. btw				
	incl. btw				

COMBOPACK

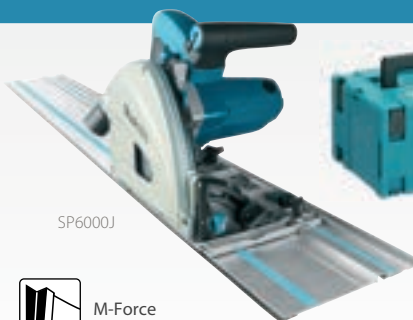

SP6000J



M-Force



4351FCTJ

MEU029J

Invalcirkelzaag	SP6000J
Decoupeerzaag	4351FCTJ
Geleiderail 1400 mm	194368-5
Extra cirkelzaagblad	B-32007
Decoupeerzaagbladen	5
Draagtas	E-05664
Prijs in €	excl. btw
	incl. btw

INVALCIRKELZAAG

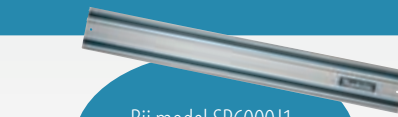

Bij model SP6000J1  
2 x geleiderail 1,4 m  
+ koppelstrips

	SP6000J	SP6000J1
Nominaal vermogen	1300 W	1300 W
Zaagdiepte (90°)	57 mm	57 mm
Zaagdiepte (45°)	40 mm	40 mm
Max. zaagdiepte (48°)	38 mm	38 mm
Ø Zaagblad	165 mm	165 mm
Gewicht	4,4 kg	4,4 kg
Prijs in €	excl. btw	
	incl. btw	

CIRKELZAGEN



5008MGJX



Zaagblad  
gratis bij 5008MGJX



HS7101JX



2 x zaagblad 12 tanden  
bij HS7101JX  
2 x zaagblad 16 tanden bij  
5903RKX1



HS0600



5143R

	HS6601	HS6101J	HS7601J	HS7101JX	5008MGJX	5903RKX1	HS0600	5103R	5143R
Nominaal vermogen	1050 W	1100 W	1200 W	1400 W	1800 W	2000 W	2000 W	2100 W	2200 W
Zaagdiepte (90°)	54,5 mm	54,5 mm	66 mm	67 mm	75,5 mm	85 mm	101 mm	100 mm	130 mm
Ø Zaagblad	165 mm	165 mm	190 mm	190 mm	210 mm	235 mm	270 mm	270 mm	355 mm
Gewicht	3,7 kg	3,7 kg	4,0 kg	4,0 kg	5,1 kg	7,2 kg	6,9 kg	9,4 kg	14,0 kg
Prijs in €	excl. btw								
	incl. btw								

TAFEL-, AFKORT- EN VERSTEKZAGEN



LF1000



LH2101



LH1201FL

**SNELLE OMBOUW  
VAN TAFEL- NAAR  
AFKORTZAAGFUNCTIE**

Verstekhoek	LH1040	LH2101	LF1000
	90°	91 x 95 mm 69 x 130 mm	95 x 155 mm 62 x 200 mm
45°	69 x 85 mm	62 x 125 mm	50 x 150 mm

		LH1040F	LH1201FL	LF1000
Nominaal vermogen		1650 W	1650 W	1650 W
Ø Zaagblad		260 mm	305 mm	260 mm
Gewicht		14,3 kg	20,7 kg	36 kg
Prijs in €	excl. btw			
	incl. btw			

AFKORT-VERSTEKZAAG



Kantelbaar naar links tot 45°

		LS1040N
Nominaal vermogen		1650 W
Ø Zaagblad		260 mm
Max. zaagdiepte 0°		91 x 95 mm
Max. zaagdiepte 45°		91 x 67 mm
Gewicht		12,4 kg
Prijs in €	excl. btw	
	incl. btw	

BOUWCIRKELZAAG



		2712
Nominaal vermogen		2000 W
Ø Zaagblad		315 mm
Max. zaagdiepte 0°		85 mm
Max. zaagdiepte 45°		58 mm
Gewicht		52,9 kg
Prijs in €	excl. btw	
	incl. btw	

TAFELZAAG MET ONDERSTEL



		2704NX1
Nominaal vermogen		1650 W
Ø Zaagblad		260 mm
Gewicht		34,9 kg
Prijs in €	excl. btw	
	incl. btw	

TAFELZAAG



Optioneel accessoire:  
JM27000300  
Onderstel MLT100N



		MLT100N
Nominaal vermogen		1500 W
Ø Zaagblad		260 mm
Gewicht		34,7 kg
Prijs in €	excl. btw	
	incl. btw	



TELESCOPISCHE AFKORT-VERSTEKZAGEN

PROMO

Gratis onderstel DEBWST06 t.w.v. bij LS1019L/LS1219L

Model	DEBWST06 - Onderstel
LS1019	✓  t.w.v.
LS1219	✓

Max. lengte: 2550 mm

Nieuwe bevestigingsklemmen voor het bevestigen van verstekzagen op onderstellen DEBWST06 en DEAWST07



JM00000219

LS0816F

- Radiaal afkortzaag met maximale werkhoogte van 65 mm
- Nauwkeurige weergave van zaaglijn door gebruik van schaduwstelsysteem
- Voorzien van ingebouwde materiaalstop en zijdelingse steunen

LS1110F

- Radiaal afkortzaag met maximale werkhoogte van 91 mm
- Nauwkeurige weergave van zaaglijn door gebruik van schaduwstelsysteem
- Voorzien van ingebouwde materiaalstop en zijdelingse steunen



LS1019L



LS0816F

Verstekhoek	LS1219L - Snijhoek		
	45° links	0°	45° rechts
0°	71x363 mm	107x363 mm	54x363 mm
45° L EN R	71x255 mm	107x255 mm	54x255 mm
60° L EN R	-	107x178 mm	-
PLINTEN	-	171 mm	-

Verstekhoek	LS1019L - Snijhoek		
	45° links	0°	45° rechts
0°	61x279 mm	91x279 mm	43x279 mm
45° L EN R	61x197 mm	91x197 mm	43x197 mm
60° L EN R	-	91x139 mm	-
PLINTEN	-	133 mm	-

Verstekhoek	LS0815FL - Snijhoek		
	45° links	0°	5° rechts
0°	50x305 mm	65x305 mm	60x305 mm
45° L EN R	50x215 mm	65x215 mm	-
60° R	-	65x150 mm	-

Verstekhoek	LS1018LN - Snijhoek		
	45° links	90°	45° rechts
0°	50x310 mm	91x310 mm	31x310 mm
45° L EN R	50x220 mm	91x220 mm	31x220 mm
60° R	-	91x153 mm	-

Verstekhoek	LS0714FLB - Snijhoek		
	45° links	90°	45° rechts
0°	40x300 mm	52x300 mm	40x300 mm
45° L EN R	40x212 mm	52x212 mm	-
57° R	-	52x163 mm	-

	LS0816F	LS0815FLN	LS1110F	LS1018LN	LS0714LN	LS1019L	LS1219L
Nominaal vermogen	1200 W	1400 W	1450 W	1430 W	1010 W	1510 W	1800 W
Ø zaagblad	216 mm	216 mm	260 mm	260 mm	190 mm	260 mm	305 mm
DXT	-	-	-	-	-	✓	✓
Gewicht	13,9	14,2 kg	16,4 kg	19,9 kg	13,4 kg	26,3 kg	29,5 kg
Prijs in €	excl. btw						
	incl. btw						

**DXT**  
Deep and Exact Cutting Technology

De gepatenteerde constructie met driefvoudige tandwieloverbrenging en uitsparing achter de flens laat toe om een groter deel van het zaagblad te benutten. Daardoor kunnen ook hoge plinten verticaal of in verstek afgekort worden.



ONDERSTEL AFKORT-VERSTEKZAGEN

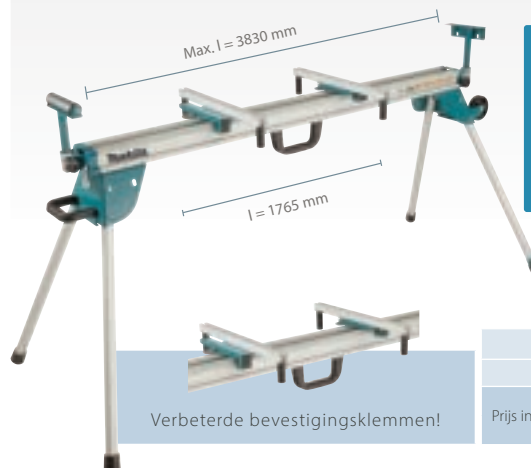

Verbeterde bevestigingsklemmen!

- Ideaal voor het zagen van lange materialen
- Vernieuwde bevestigingsklemmen met een veilig en handig kliksysteem om moeiteloos verstekzagen te installeren en te demonteren.
- Gemakkelijk te transporteren

		DEAWST07
Afmetingen		1765 (l) x 750 (b) x 850 (h) mm
Max. lengte		3830 mm
Prijs in €	excl. btw	
	incl. btw	

HANDPALMVLAKSCHUURMACHINES



	BO4556K	BO4555K	BO4558	BO4565K
Nominaal vermogen	200 W	200 W	200 W	200 W
Afmetingen schuurvoet	112 x 102 mm	112 x 102 mm	112 x 102 mm	112 x 190 mm
Bevestiging	Klem	Velcro & klem	Klem	Velcro Driehoekspunt
Materiaal schuurvoet	Kunststof	Kunststof	Aluminium	Kunststof
Aantal schuurbewegingen	14000/min	14000/min	14000/min	14000/min
Schuuruitslag	1,5 mm	1,5 mm	1,5 mm	1,5 mm
Gewicht	1,1 kg	1,1 kg	1,2 kg	1,2 kg
Prijs in €	excl. btw			
	incl. btw			



VLAKSCHUURMACHINES MET VARIABLE SNELHEID



BO3711

	BO3711	BO4900VJ
Nominaal vermogen	190 W	330 W
Afmetingen schuurvoet	93 x 185 mm	115 x 232 mm
Aantal schuurbewegingen	4000-11000/min	4000-10000/min
Schuuruitslag	2,0 mm	2,6 mm
Gewicht	1,6 kg	2,7 kg
Prijs in €	excl. btw	
	incl. btw	

BANDSCHUURMACHINES

9403J:  
Zeer krachtig,  
ideaal voor intensief  
schuurwerk

9403J

9911J

9032



	9911J	9924DB	9903J	9031	9032	9920J	9404J	9403J
Nominaal vermogen	650 W	850 W	1010 W	550 W	500 W	1010 W	1010 W	1200 W
Bandsnelheid	75-270 m/min	400 m/min	210-440 m/min	200-1000 m/min	300-1700 m/min	210-440 m/min	210-440 m/min	500 m/min
Schuurband	75 x 457 mm	75 x 610 mm	75 x 533 mm	30 x 533 mm	9 x 533 mm	75 x 610 mm	100 x 610 mm	100 x 610 mm
Gewicht	2,7 kg	4,8 kg	4,3 kg	2,1 kg	1,6 kg	4,5 kg	4,8 kg	5,7 kg
Prijs in €	excl. btw							
	incl. btw							

EXCENTRISCHE SCHUURMACHINES



BO5031K



BO5041K



BO6050J

	BO5031K	BO5041K	BO6030JX	BO6050J
Nominaal vermogen	300 W	300 W	310 W	750 W
Aantal schuurbewegingen	8000-24000/min	8000-24000/min	8000-20000/min	3200-13600/min
Schuuruitslag	2,8 mm	2,8 mm	3 mm	5,5 mm
Ø Schuurvoet	123 mm	123 mm	147 mm	147 mm
Gewicht	1,3 kg	1,4 kg	2,4 kg	2,6 kg
Prijs in €	excl. btw			
	incl. btw			

HAAKSE SCHUURMACHINE



SA7000C

SA7000C	
Nominaal vermogen	1600 W
Toerental onbelast	0-4000 t.p.m
Ø schijf	180 mm
Gewicht	3,4 kg
Prijs in €	excl. btw
	incl. btw

EXCENTRISCHE POLIJSTMACHINE



PO6000C

PO6000C	
Nominaal vermogen	890 W
Aantal schuurbewegingen	0-13600/min.
Ø schijf	150 mm
Schuuruitslag	5,5 mm
Gewicht	2,7 kg
Prijs in €	excl. btw
	incl. btw

SCHUUR- EN POETSMACHINE



9237CB

9237CB	
Nominaal vermogen	1200 W
Toerental	0-3200 t.p.m.
Ø schijf	180 mm
Gewicht	3,4 kg
Prijs in €	excl. btw
	incl. btw

BORSTELSCUURMACHINE



9741J

9741J	
Nominaal vermogen	860 W
Toerental	3500 t.p.m.
Gewicht	4,2 kg
Prijs in €	excl. btw
	incl. btw



GASNAGELPISTOOL VOOR  
AFWERKNAGELS 16 GA



**GF600SE**

Accu	7,2 V / 1,0 Ah
Gemiddelde laadtijd	30 min
Doorsnede nagel	1,6 mm
Lengte nagel	15-64 mm
Gewicht	2,2 kg
Prijs in €	excl. btw
	incl. btw

GASNAGELPISTOOL  
VOOR BETON



**GN420CSE**

Accu	7,2 V / 1,0 Ah
Gemiddelde laadtijd	30 min
Doorsnede nagel	2,6-3,0 mm
Lengte nagel	15-40 mm
Gewicht	3,5 kg
Prijs in €	excl. btw
	incl. btw

GASNAGELPISTOOL VOOR  
HOUT



**GN900SE**

Accu	7,2 V / 1,0 Ah
Gemiddelde laadtijd	30 min
Doorsnede nagel	2,9-3,3 mm
Lengte nagel	50-90 mm
Gewicht	3,3 kg
Prijs in €	excl. btw
	incl. btw

COMPRESSOR 230V



**MAC210Q**

- Compacte 1 pk luchtcompressor, ideaal voor gebruik in combinatie met kleine perslucht-gereedschappen zoals nagelaars
- Laag toerental: vermindert het geluidsniveau en verlengt de levensduur van de pomp
- Compacte rolkooiconstructie, draagbaar
- Olievrije pomp met twee cilinders
- Twee grote manometers

**MAC210Q**

Voeding	230 V AC
Luchtdebiet	48 l/min @ 6,2 bar
Werkdruk	0 - 9,3 bar
Tankinhoud	7,6 l
Geluidsdruk	60 dB (A)
Gewicht	22 kg
Prijs in €	excl. btw
	incl. btw

PNEUMATISCH CONSTRUCTIE-  
NAGELPISTOOL 21°



**AN924**

Werkdruk	4,9-8,3 bar
Doorsnede nagel	3,76 mm
Lengte nagel	50-90 mm
Gewicht	3,8 kg
Prijs in €	excl. btw
	incl. btw

MINIBRADPISTOOL 18 GA



**AF506**

Werkdruk	4,8-8,3 bar
Draadkaliber	18 Ga
Ø Nagelkop	2,0 mm
Doorsnede nagel	1,2 mm
Lengte nagel	15-50 mm
Gewicht	1,4 kg
Prijs in €	excl. btw
	incl. btw

BRADPISTOOL 16 GA



**AF601**

Werkdruk	0,49 - 8,3 bar
Draadkaliber	16 Ga
Doorsnede nagel	1,6 mm
Lengte nagel	25 - 64 mm
Gewicht	1,7 kg
Prijs in €	excl. btw
	incl. btw

PNEUMATISCH  
CONSTRUCTIENAGELPISTOOL 34°



**AN943K**

Werkdruk	4,5-8,5 bar
Ø Nagelkop	7,0 mm
Doorsnede nagel	2,9-3,3 mm
Lengte nagel	50-90 mm
Gewicht	3,9 kg
Prijs in €	excl. btw
	incl. btw

LASERAFSTANDSMETER



LD080PI



LD030P



	LD030P	LD050P	LD080PI
Bereik	30 m	50 m	80 m
Gewicht	0,1 kg	0,1 kg	0,1 kg
Prijs in €	excl. btw		
	incl. btw		

ROTERENDE LASER



PROMO  
gratis statief 2,7 m  
t.w.v.



Inclusief ontvanger, bril voor laser, afstandsbediening en wandbevestiging

		SKR200Z
Rotatiesnelheid		0-600 t.p.m.
Bereik		100 m
Gewicht		1,6 kg
Prijs in €	excl. btw	
	incl. btw	

ACCU MUURSCANNER



De DWD181 gebruikt radartechnologie om nauwkeurig metaal, hout, elektrische bekabeling en andere objecten in wanden en vloeren te detecteren

4,1 inch kleurenscherm

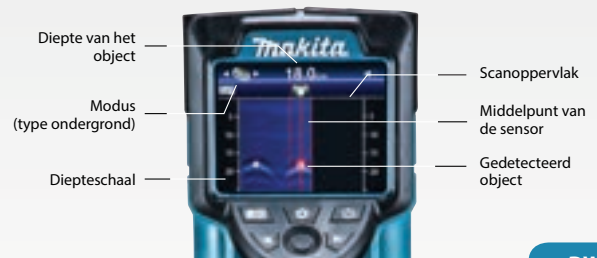

		DWD181ZJ
Spanning		14,4V/18V
Max. detectiediepte		25 - 180 mm
Tolerantie detectiediepte		± 5 mm
Minimum detecteerbare afstand tussen objecten		40 mm
Bijgeleverde lader/accu		-
Gewicht zonder accu		1,0 kg
Prijs in €	excl. btw	
	incl. btw	

KRUISLIJN- EN LIJNLASERS (CXT)

SK105DZ, SK105GDZ & SK106GDZ  
PROMO  
Incl. BL1021B + DC10SB



SK105DZ



SK106GDZ

Kruislijn

SK105GD



SK105D



Kruislijn + 4 punten

SK106GD

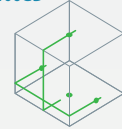

SK105DZ SK105GDZ SK106GDZ

Kleur	Rood	Groen	Groen
Projecties	1 H - 1 V	1 H - 1 V	1 H - 1 V + 4 punten
Nauwkeurigheid	+3 mm / 10 m	+3 mm / 10 m	+3 mm / 10 m
Bereik	25 m	25 m	25 m
Bijgeleverde accu's	1 x BL1021B + DC10SB	1 x BL1021B + DC10SB	1 x BL1021B + DC10SB
Gewicht	0,67 kg	0,67 kg	0,69 kg
Prijs in €	excl. btw		
	incl. btw		

**SK10GD/SK20GD/SK40GD**

- Groene laser met hoge helderheid
- Uiterst nauwkeurig
- Stevige constructie, beschermingsklasse IP54

Horizontaal / 4-Verticale lijnen

Horizontaal / 2-Verticale lijnen

Kruislijn + Punt

SK40GD

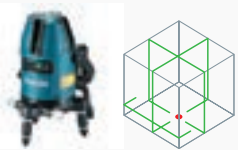

SK20GD



SK10GD

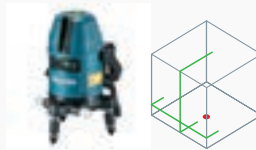

SK10GDZ, SK20GDZ, SK40GDZ, SK209GDZ & SK312GDZ  
PROMO  
gratis powerpack 197658-5



1 horizontale + 2 verticale lijnen

SK209GD



1 horizontale + 3 verticale lijnen

SK312GD



SK209GDZ



SK312GDZ

SK10GDZ SK20GDZ SK40GDZ SK209GDZ SK312GDZ

Kleur	Groen	Groen	Groen	Groen	Groen
Projecties	1 H - 1 V + loodpunt	1 H - 2 V + loodpunt	1 H - 4 V + loodpunt	1 H - 2 V + loodpunt	1 H - 3 V + loodpunt
Nauwkeurigheid	±1 mm/10m	±1 mm/10m	±1 mm/10m	+1 mm / 10 m	+1 mm / 10 m
Bereik	-	-	-	-	-
Bijgeleverde accu's	2x BL1021B + DC10SB	2x BL1021B + DC10SB	2x BL1021B + DC10SB	2x BL1021B + DC10SB	2x BL1021B + DC10SB
Gewicht	1,4 - 1,6 kg	1,4 - 1,6 kg	1,4 - 1,6 kg	1,5 - 1,6 kg	1,5 - 1,6 kg
Prijs in €	excl. btw				
	incl. btw				



KRUISLIJN- EN LIJNLASERS (CXT)

**SK700DZ/SK700GDZ:**

- 3x 360° laser (3 stralen: 1 horizontaal 360° + 2 verticaal 360°).
- Zeer hoge nauwkeurigheid.
- Blokkeerstand voor projectie van schuine lijnen en voor transport.
- Zeer grote autonomie dankzij de 12Vmax CXT batterij.
- IP54 bescherming.

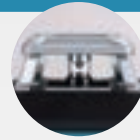

Via een sneldraaiende conische spiegel wordt de laserstraal over 360° geprojecteerd.

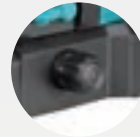

**Fijnafstelling:** Via een knop op de basis kan de unit zeer precies over een bereik van 10° gedraaid worden. De bevestiging is excentrisch zodat de kruising van de lijnen bij het draaien op hetzelfde punt blijft.

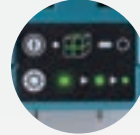

**Helderheidsinstelling**  
Via de 3 helderheidsinstellingen (100% – 75% – 50%) kan de intensiteit van de laser perfect aangepast worden aan de omstandigheden.

**Hoge intensiteit**  
De SK700GDZ met krachtige groene laser biedt een uitstekende zichtbaarheid, ook in een omgeving met invallend daglicht.



SK700DZ



SK700GDZ



SK700DZ & SK700GDZ  
**INCLUSIEF:**  
Powerpack 197658-5  
t.w.v.



**OPTIONEEL**  
CPO0000001

ADP09 Batterij adapter voor SK700  
Werkt met 8 x 1,5V AA-batterijen  
excl btw:  
incl btw:



	SK700DZ	SK700GDZ
Kleur	Rood	Groen
Projecties	3 x 360° rood	3 x 360° groen
Nauwkeurigheid	±2mm/10m	±2mm/10m
Bereik	25 m	35 m
Bijgeleverde accu's	2x BL1021B + DC105B	2x BL1021B + DC105B
Gewicht	0,99 – 1,2 kg	0,99 – 1,2 kg
Prijs in €	excl. btw	
	incl. btw	

**Accessories**

**TK0LM2000F**

Statief 400 - 1140 mm  
excl btw:  
incl btw:



**TK0LM4001F**

Statief 680 - 1800 mm  
excl btw:  
incl btw:



**TK0LM5030F**

Statief 780 - 2900 mm  
excl btw:  
incl btw:



**LE00870137**

Muur- en plafondbevestiging SK105, SK106, SK700  
excl btw:  
incl btw:



**TK00ET03F1**

Muur- en plafondbevestiging SK10, SK20, SK40, SK209, SK312  
excl btw:  
incl btw:



**LE00855702**

Laserlijntvanger (80 m) SK105, SK106, SK700  
excl btw:  
incl btw:



**TK0LDG501G**

Laserlijntvanger SK10, SK20, SK40  
excl btw:  
incl btw:



**TK0LDG301G**

Laserlijntvanger SK209, SK312  
excl btw:  
incl btw:



**DECADP05**

Adapter voor LXT batterijen  
excl btw:  
incl btw:



**199178-5**

USB voedingskabel voor ADP05 (SK105 / SK106)  
excl btw:  
incl btw:



**199010-3**

USB voedingskabel voor ADP05 (SK209 / SK312)  
excl btw:  
incl btw:





UC100D / DUC101 / DUC150 ACCU SNOEIZAGEN



DUC101SF

	UC100DZ	DUC101Z	DUC101SF	DUC150Z
Spanning	10,8V (12Vmax)	18V	18V	18V
Bijgeleverde accu's	-	-	1x accu 3,0 Ah	-
Bijgeleverde lader	-	-	DC18SD	-
BL motor	✓	✓	✓	✓
Snelspansysteem	✓	✓	✓	✓
Zwaardlengte	100 mm	100 mm	100 mm	150 mm
Ketting	80 TXL (0,325, 1,1 mm)	80 TXL (0,325, 1,1 mm)	80 TXL (0,325, 1,1 mm)	80 TXL (0,325, 1,1 mm)
Kettingsnelheid	8 m/s	8 m/s	8 m/s	8 m/s
Gewicht	1,5-1,6 kg	1,6-2,0 kg	1,6-2,0 kg	1,7-2,0 kg
Prijs in €	excl. btw			
	incl. btw			

Optioneel accessoire:

Holster



Ref.	Prijs (Excl. BTW)	Prijs (Incl. BTW)
------	-------------------	-------------------

1913K4-9

Geschikt voor DUC101 / DUC150



DUA301 ACCU HOOGSNOEIER 2 x 18V



DUA301Z

	DUA301Z	DUA301PT2
Spanning	2x 18V	2x 18V
Bijgeleverde accu's	0	2x 5,0 Ah
Bijgeleverde lader	-	DC18RD
BL motor	✓	✓
Totale lengte	2,53 - 3,76 m	2,53 - 3,76 m
Bevestiging zwaard	Geïntegreerde moer	Geïntegreerde moer
Zwaardlengte	30 cm	30 cm
Ketting	90PX (0,325", 1,1 mm)	90PX (0,325", 1,1 mm)
Kettingsnelheid	0 - 20 m/s	0 - 20 m/s
Gewicht	7,8 - 8,5 kg	7,8 - 8,5 kg
Prijs in €	excl. btw	
	incl. btw	

UA004G ACCU HOOGSNOEIER 40VMAX

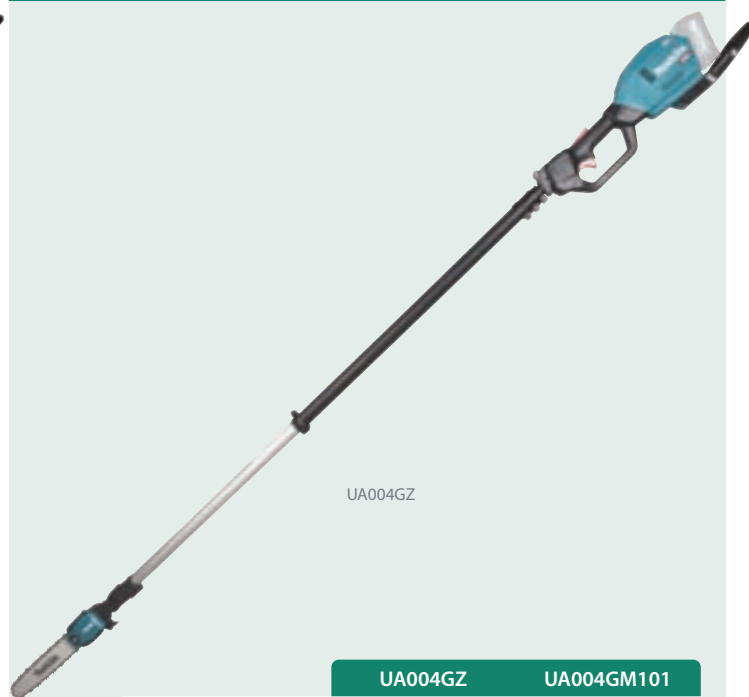

UA004GZ

	UA004GZ	UA004GM101
Spanning	36V (40Vmax)	36V (40Vmax)
Bijgeleverde accu's	-	1x 4,0 Ah
Bijgeleverde lader	-	DC40RA
BL motor	✓	✓
Totale lengte	2,53 - 3,76 m	2,53 - 3,76 m
Bevestiging zwaard	Geïntegreerde moer	Geïntegreerde moer
Zwaardlengte	30 cm	30 cm
Ketting	90PX (0,325", 1,1 mm)	90PX (0,325", 1,1 mm)
Kettingsnelheid	0 - 20 m/s	0 - 20 m/s
Gewicht	7,8 - 9,1 kg	7,8 - 9,1 kg
Prijs in €	excl. btw	
	incl. btw	



**DUC122 / DUC254 ACCU SNOEIKETTINGZAGEN 18V**



DUC122ZK

DUC254Z001

	DUC122ZK	DUC122RTE	DUC254Z001
Spanning	18V	18V	18V
Bijgeleverde accu's	-	2 x accu 5,0 Ah	-
Bijgeleverde lader	-	DC18RC	-
BL motor	-	-	✓
Spansysteem	Snelspansysteem	Snelspansysteem	Geïntegreerde moeren
Zwaardlengte	11,5 cm	11,5 cm	25 cm
Ketting	025 (1/4", 1,3 mm)	025 (1/4", 1,3 mm)	80PX (0,325", 1,1 mm)
Kettingsnelheid	5 m/s	5 m/s	24 m/s
Gewicht	2,6 kg	2,6 kg	2,8 - 3,2 kg
Prijs in €	excl. btw		
	incl. btw		

**DUC256 / DUC306 / DUC356 / DUC406**

ACCU SNOEIKETTINGZAGEN 2 x 18V



DUC256Z001

**Promo!**  
gratis 87-delige gereedschapsset E-08458

	DUC256Z001	DUC306Z001	DUC356Z001	DUC406Z001
Spanning	2x 18V	2x 18V	2x 18V	2x 18V
Bijgeleverde accu's	-	-	-	-
Bijgeleverde lader	-	-	-	-
BL motor	✓	✓	✓	✓
Snelspansysteem	-	-	-	-
Geïntegreerde moeren	✓	✓	✓	✓
Zwaardlengte	25 cm	30 cm	35 cm	40 cm
Ketting	80 TXL (0,325, 1,1 mm)	80 TXL (0,325, 1,1 mm)	80 TXL (0,325, 1,1 mm)	80 TXL (0,325, 1,1 mm)
Kettingsnelheid	20 m/s	20 m/s	20 m/s	20 m/s
Gewicht	4,6-5,1 kg	4,6-5,1 kg	4,6-5,1 kg	4,6-5,1 kg
Prijs in €	excl. btw			
	incl. btw			

**UC002G / UC003G / UC004G / UC006G ACCU SNOEIKETTINGZAGEN 40VMAX**



UC003GZ

UC004GZ

UC006GZ

**Promo!**  
Gratis blaasmachine AS001GZ na online registratie UC002GM101, UC003GM101 & UC004GM101



	UC002GZ	UC002GM101	UC003GZ	UC003GM101	UC004GZ	UC004GM101	UC006GZ
Spanning	36V (40Vmax)	36V (40Vmax)	36V (40Vmax)	36V (40Vmax)	36V (40Vmax)	36V (40Vmax)	36V (40Vmax)
Bijgeleverde accu's	-	1x 4,0 Ah	-	1x 4,0 Ah	-	1x 4,0 Ah	-
Bijgeleverde lader	-	DC40RA	-	DC40RA	-	DC40RA	-
BL motor	✓	✓	✓	✓	✓	✓	✓
Geïntegreerde moeren	✓	✓	✓	✓	✓	✓	✓
Zwaardlengte	25 cm	25 cm	30 cm	30 cm	35 cm	35 cm	25 cm Carving
Ketting	90PX (3/8" 1,1 mm)	90PX (3/8" 1,1 mm)	90PX (3/8" 1,1 mm)	90PX (3/8" 1,1 mm)	90PX (3/8" 1,1 mm)	90PX (3/8" 1,1 mm)	90PX (1/4", 1,3 mm)
Kettingsnelheid	0 - 24,8 m/s	0 - 24,8 m/s	0 - 24,8 m/s	0 - 24,8 m/s	0 - 24,8 m/s	0 - 24,8 m/s	0 - 24,8 m/s
Gewicht	3,8 - 4,7 kg	3,8 - 4,7 kg	3,8 - 4,7 kg	3,8 - 4,7 kg	3,8 - 4,7 kg	3,8 - 4,7 kg	3,8 - 4,7 kg
Prijs in €	excl. btw						
	incl. btw						

KETTINGZAAGOLIE



1910U0-9



1910U1-7



195093-1



1910T9-4



Te gebruiken als reinigingsmiddel en corrosiebescherming bij langdurig stilstaan van uw kettingzagen.

1910U6-7



	1910U0-9	1910U1-7	195093-1	1910T9-4	1910U6-7
Omschrijving	Kettingzaagolie Biotop	Kettingzaagolie Biotop	Kettingzaagolie (mineraal)	Kettingzaagolie (mineraal)	Corrosiebeschermingsolie
Inhoud	1l	5l	1l	5l	0,25l
Prijs in €	excl. btw				
	incl. btw				

DUC307 / DUC357 ACCU KETTINGZAGEN 18V



DUC357RTX2

	DUC307ZX2	DUC307RTX2	DUC357ZX2	DUC357RTX2
Spanning	18V	18V	18V	18V
Bijgeleverde accu's	-	1x 5,0 Ah	-	1x 5,0 Ah
Bijgeleverde lader	-	DC18RC	-	DC18RC
BL motor	✓	✓	✓	✓
Snelspanstelsysteem	✓	✓	✓	✓
Zwaardlengte	30 cm	30 cm	35 cm	35 cm
Ketting	90PX (3/8", 1,1 mm)	90PX (3/8", 1,1 mm)	90PX (3/8", 1,1 mm)	90PX (3/8", 1,1 mm)
Kettingsnelheid	7,7 m/s	7,7 m/s	7,7 m/s	7,7 m/s
Gewicht	4,2 - 4,4 kg	4,2 - 4,4 kg	4,2 - 4,4 kg	4,2 - 4,4 kg
Prijs in €	excl. btw			
	incl. btw			

DUC353 / DUC405 ACCU KETTINGZAGEN 2 x 18V



DUC405Z



**\*Promo!**  
Gratis accu 5,0 Ah na online registratie



	DUC353Z	DUC405Z
Spanning	2x 18V	2x 18V
Bijgeleverde accu's	-	-
Bijgeleverde lader	-	-
BL motor	✓	✓
Zwaardlengte	35 cm	40 cm
Bevestiging zwaard	Snelspanstelsysteem	Geïntegreerde moeren
Ketting	90PX (3/8", 1,1 mm)	90PX (3/8", 1,1 mm)
Kettingsnelheid	20 m/s	20 m/s
Gewicht	4,6 - 5,5 kg	4,6 - 5,5 kg
Prijs in €	excl. btw	
	incl. btw	

UC021G / UC022G / UC023G / UC024G / UC025G / UC026G ACCU KETTINGZAGEN 40VMAX



**NIEUW!**



UC021G  
(gereedschapsloze kettingspanner)

UC025G  
(geïntegreerde moeren)

**UC021G-UC026G**

- Krachtige accukettingzaag met een uitstekende vermogen/gewichtsverhouding
- Hoge kettingsnelheid en snelle acceleratie
- Natuurlijk aanvoelen van de belasting zoals bij een benzine kettingzaag, dit voorkomt onverwacht stoppen door overbelasting

	NIEUW UC021GZ	NIEUW UC022GZ	NIEUW UC023GZ	NIEUW UC024GZ	NIEUW UC025GZ	NIEUW UC026GZ
Spanning	36V (40Vmax)	36V (40Vmax)	36V (40Vmax)	36V (40Vmax)	36V (40Vmax)	36V (40Vmax)
Bijgeleverde accu's	-	-	-	-	-	-
Bijgeleverde lader	-	-	-	-	-	-
BL motor	✓	✓	✓	✓	✓	✓
Zwaardbevestiging	Gereedschapsloze kettingspanner	Gereedschapsloze kettingspanner	Gereedschapsloze kettingspanner	Geïntegreerde moeren	Geïntegreerde moeren	Geïntegreerde moeren
Zwaardlengte	30 cm	35 cm	40 cm	30 cm	35 cm	40 cm
Ketting	80TXL (0,325, 1,1 mm)	80TXL (0,325, 1,1 mm)	80TXL (0,325, 1,1 mm)	80TXL (0,325, 1,1 mm)	80TXL (0,325, 1,1 mm)	80TXL (0,325, 1,1 mm)
Kettingsnelheid	0 - 25,5 m/s	0 - 25,5 m/s	0 - 25,5 m/s	0 - 25,5 m/s	0 - 25,5 m/s	0 - 25,5 m/s
Gewicht	5,3 kg - 5,5 kg	5,3 kg - 5,5 kg	5,3 kg - 5,5 kg	5,3 kg - 5,5 kg	5,3 kg - 5,5 kg	5,3 kg - 5,5 kg
Prijs in €	excl. btw					
	incl. btw					

UC010G / UC011G / UC012G / UC013G ACCU KETTINGZAGEN 40VMAX



**Promo!**

Gratis blaasmachine AS001GZ na online registratie UC010GT101, UC011GT101, UC012GT102 & UC013GT102



UC012GT102

UC013GT102

	UC010GZ	UC010GT101	UC011GZ	UC011GT101	UC012GZ01	UC012GT102	UC013GZ01	UC013GT102
Spanning	36V (40Vmax)	36V (40Vmax)	36V (40Vmax)	36V (40Vmax)	36V (40Vmax)	36V (40Vmax)	36V (40Vmax)	36V (40Vmax)
Bijgeleverde accu's	-	1 x 5,0 Ah	-	1 x 5,0 Ah	-	1 x 5,0 Ah	-	1 x 5,0 Ah
Bijgeleverde lader	-	DC40RA	-	DC40RA	-	DC40RA	-	DC40RA
BL motor	✓	✓	✓	✓	✓	✓	✓	✓
Geïntegreerde moeren	✓	✓	✓	✓	✓	✓	✓	✓
Zwaardlengte	30 cm	30 cm	35 cm	35 cm	40 cm	40 cm	45 cm	45 cm
Ketting	80TXL (0,325, 1,1 mm)	80TXL (0,325, 1,1 mm)	80TXL (0,325, 1,1 mm)	80TXL (0,325, 1,1 mm)	3/8" 1,3 mm	3/8" 1,3 mm	3/8" 1,3 mm	3/8" 1,3 mm
Kettingsnelheid	0 - 25,5 m/s	0 - 25,5 m/s	0 - 25,5 m/s	0 - 25,5 m/s	0 - 25,5 m/s	0 - 25,5 m/s	0 - 25,5 m/s	0 - 25,5 m/s
Gewicht	6,1 - 7,4 kg	6,1 - 7,4 kg	6,1 - 7,4 kg	6,1 - 7,4 kg	6,1 - 7,4 kg	6,1 - 7,4 kg	6,1 - 7,4 kg	6,1 - 7,4 kg
Prijs in €	excl. btw							
	incl. btw							



**DUR193 ACCU GRASTRIMMER 18V**

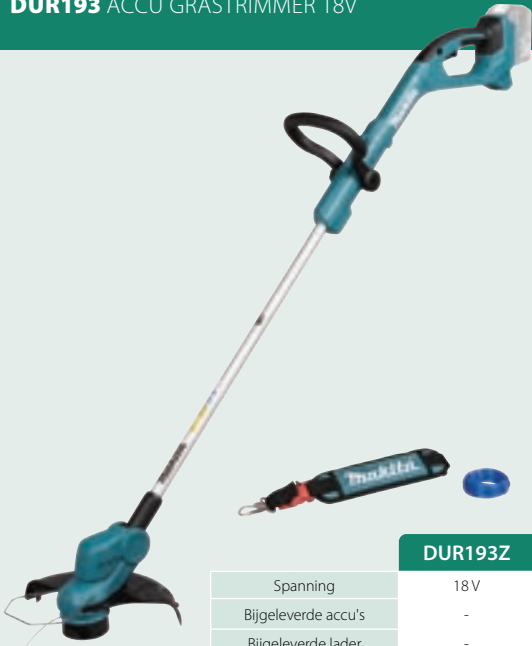

	DUR193Z	DUR193RF
Spanning	18V	18V
Bijgeleverde accu's	-	1 x accu 3,0 Ah
Bijgeleverde lader	-	DC18RC
Snelheden	1	1
BL motor	-	-
ADT	-	-
AFT	-	-
Handgreep	Rond ("D")	Rond ("D")
Schacht	Telescopisch	Telescopisch
Max. uitgangsvermogen	280 W	280 W
Gewicht	2,3 - 2,6 kg	2,3 - 2,6 kg
Prijs in €	excl. btw	
	incl. btw	

**DUR192 ACCU GRASTRIMMER 18V**



	DUR192LZ	DUR192LST
Spanning	18V	18V
Bijgeleverde accu's	-	1 x accu 5,0 Ah
Bijgeleverde lader	-	DC18SD
Snelheden	2	2
ADT	-	-
AFT	-	-
Handgreep	Rond ("D")	Rond ("D")
Max. uitgangsvermogen	460 W	460 W
Gewicht	3,4 kg	3,4 kg
Prijs in €	excl. btw	
	incl. btw	

**DUR194 ACCU GRASTRIMMER 18V**



	DUR194ZX3	DUR194SFX2	DUR194RTX1
Spanning	18V	18V	18V
Bijgeleverde accu's	-	1x accu 3,0 Ah	1x accu 5,0 Ah
Bijgeleverde lader	-	DC18SD	DC18RC
Snelheden	2	2	2
BL motor	-	-	-
ADT	-	-	-
AFT	-	-	-
Handgreep	D	D	D
Max. uitgangsvermogen	230 W	230 W	230 W
Gewicht	2,6 - 2,9 kg	2,6 - 2,9 kg	2,6 - 2,9 kg
Prijs in €	excl. btw		
	incl. btw		

**DUR189 ACCU GRASTRIMMERS 18V**

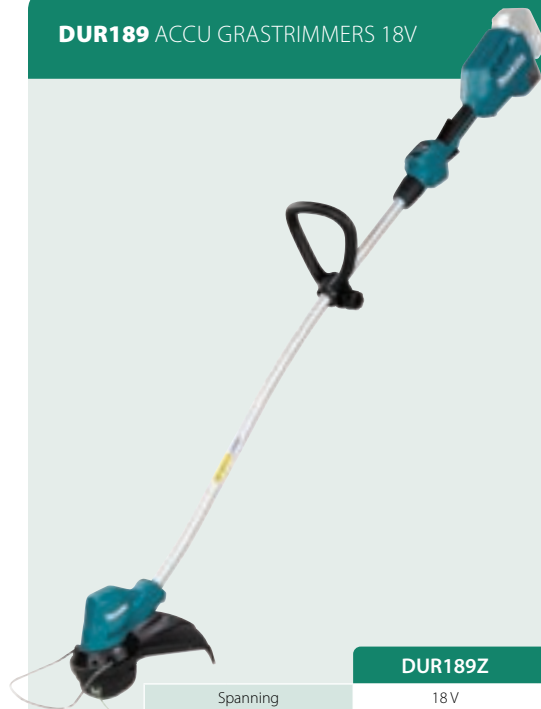

	DUR189Z	DUR189RFE
Spanning	18V	18V
Bijgeleverde accu's	0	2 x BL1830B
Snelheden	3 mm	3 mm
ADT	✓	✓
AFT	-	-
Handgreepvorm	D	D
Max. uitgangsvermogen	240 W	240 W
Gewicht	3,0 - 3,3 kg	3,0 - 3,3 kg
Prijs in €	excl. btw	
	incl. btw	

**DUR190 / DUR191 ACCU GRASTRIMMERS 18 V**



**Promo!**  
Gratis BL1850B na online registratie DUR190UT11



	DUR190LZX9	DUR190UT11	DUR191LZX3	DUR191LZX9
Spanning	18V	18V	18V	18V
Bijgeleverde accu's	-	1x BL1850B	-	-
Lader	-	DC18SD	-	-
Snelheden	3	3	3	3
ADT	✓	✓	✓	✓
AFT	✓	✓	✓	✓
Handgreepvorm	D	U	D	D
Easy-fill maaikop	✓	✓	-	✓
Max. uitgangsvermogen	240 W	240 W	240 W	240 W
Gewicht	2,9 - 3,2 kg	3,4 - 3,7 kg	3,2 - 3,5 kg	3,2 - 3,5 kg
Prijs in €	excl. btw			
	incl. btw			



**DUR368 / DUR369 ACCU BOSMAAIERS 2x18V**



**Promo!**  
Gratis accu 5,0 Ah na online registratie

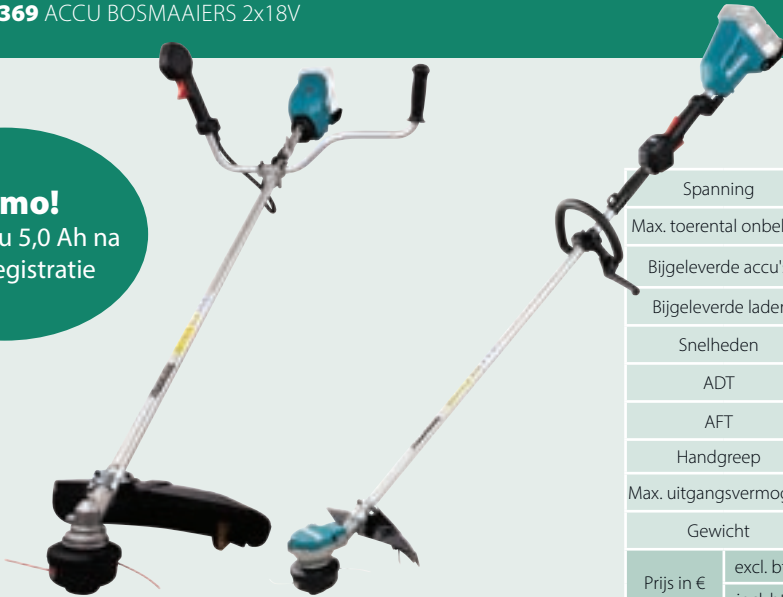

	DUR368LZ	DUR368AZ	DUR369AZ
Spanning	2x 18V	2x 18V	2x 18V
Max. toerental onbelast	6500 t.p.m.	6500 t.p.m.	7000 t.p.m.
Bijgeleverde accu's	-	-	-
Bijgeleverde lader	-	-	-
Snelheden	3	3	3
ADT	✓	✓	✓
AFT	✓	✓	✓
Handgreep	D	U	U
Max. uitgangsvermogen	550 W	550 W	1000 W
Gewicht	3,9 - 4,5 kg	4,1 - 4,7 kg	5,9 - 6,5 kg
Prijs in €	excl. btw		
	incl. btw		

### UR012G

ACCU BOSMAAIER 2 x 40VMAX



UR012GZ02

#### UR012GZ02

Spanning	2 x 40Vmax	
Max. toeren onbelast	3500 - 5000 - 6800 min <sup>-1</sup>	
Snelheden	3 + auto	
ADT	✓	
AFT	✓	
Bijgeleverde accu's	-	
Bijgeleverde lader	-	
Max. uitgangsvermogen	2,0 kW	
Gewicht	8,0 - 9,3 kg	
Prijs in €	excl. btw	
	incl. btw	

Max. uitgangsvermogen  
**2,0 kW**

### UR013G / UR014G

ACCU BOSMAAIERS 40VMAX



UR013GZ04

UR014GZ

#### UR013G/UR014G

Extra hoog koppel in "High torque mode", bijzonder geschikt voor zware toepassingen

#### UR014G

- enkel te gebruiken met draadkop
- de draairichting is omkeerbaar

#### UR013GZ04

#### UR014GZ

Spanning	36V (40Vmax)	36V (40Vmax)
Toerental onbelast	3500 - 6700 min <sup>-1</sup>	4000 - 5000 min <sup>-1</sup>
Bijgeleverde accu's	-	-
Bijgeleverde lader	-	-
Handgreepvorm	Dubbel ("U")	Rond ("D")
ADT	-	-
AFT	✓	✓
Max. uitgangsvermogen	1500 W	1500 W
Gewicht	5,9 - 7,2 kg	5,5 - 6,7 kg
Prijs in €	excl. btw	
	incl. btw	

### UR016G / UR017G

ACCU BOSMAAIERS 40VMAX



UR016GZ

#### UR016GZ

#### UR017GZ

Spanning	36V (40Vmax)	36V (40Vmax)
Bijgeleverde accu's	-	-
Bijgeleverde lader	-	-
Toerental onbelast	3500/5300/6500 min <sup>-1</sup>	3500/5300/6500 min <sup>-1</sup>
Handgreepvorm	Dubbel ("U")	Rond ("D")
ADT	✓	✓
AFT	✓	✓
Max. uitgangsvermogen	600 W	600 W
Prijs in €	excl. btw	
	incl. btw	

### UR002G / UR006G / UR007G

ACCU BOSMAAIERS 40VMAX

### PROMO

Gratis AS001GZ na online registratie UR006GM102



UR002GZ01

UR006GM102



#### UR002GZ01

#### UR006GZ02

#### UR006GM102

#### UR007GZ01

Spanning	36V (40Vmax)	36V (40Vmax)	36V (40Vmax)	36V (40Vmax)
Max. toerental onbelast	3500 - 5300 - 6500 min <sup>-1</sup>	4600 - 5500 - 7000 min <sup>-1</sup>	4600 - 5500 - 7000 min <sup>-1</sup>	4600 - 5500 - 7000 min <sup>-1</sup>
Snelheden	3 + auto	3 + auto	3 + auto	3 + auto
Handgreepvorm	Dubbel ("U")	Dubbel ("U")	Dubbel ("U")	Rond ("D")
ADT	✓	✓	✓	✓
AFT	✓	✓	✓	✓
Bijgeleverde accu's	0	0	1x BL4040	0
Bijgeleverde lader	0	0	1x DC40RA	0
Max. uitgangsvermogen	550 W	1 kW	1 kW	1 kW
Gewicht	4,6 - 5,3 kg	5,7 - 6,3 kg	5,7 - 6,3 kg	5,7 - 6,3 kg
Prijs in €	excl. btw			
	incl. btw			



# PDC: Makita's accupack platform

PDC01 - PDC1200 - PDC1500



## VERBINDING PDC VIA STANDAARD CONNECTOR



UB001C  
UB003C



VR00xC  
Betontrilnaalden



UR101C



PDC01  
432 Wh max.



PDC1200  
1206 Wh



PDC1500  
1567,8 Wh

## BEVESTIGING PDC OP DE MACHINE



LM001C



UB002C



UB004C



BAC01



De BAC01 in combinatie met PDC levert een 230 V wisselspanning op locatie.

## VERBINDING PDC MET LXT/XGT TOOLS



18V LXT \*



2 x 18V LXT



XGT  
40V<sup>Li-Ion</sup>  
max



191J50-7  
Adapter 18V LXT\*

191J51-5  
Adapter 2x18V LXT



\* 18V LXT enkel in combinatie met PDC01



Combinatie met PDC01  
(Ref. BAC01PDC01BE)



Combinatie met PDC1200  
(Ref. BAC01PDC1200BE)

	EUABAC01	BAC01PDC01BE	BAC01PDC1200BE
Uitvoering	BAC01	BAC01+PDC01*	BAC01+PDC1200
Prijs €	excl. btw		
	incl. btw		

	PDC01		
Bestelreferentie	191A64-2	191A59-5	191C50-5
Accu	1 tot 4 LXT accu's	1 tot 4 LXT accu's	1 tot 4 LXT accu's
Energiecapaciteit	Max. 432 Wh	Max. 432 Wh	Max. 432 Wh
Meegeleverde adapters	2x18V (191J51-5)	2x18V (191J51-5)	2x18V (191J51-5)
Bijgeleverde accu's	-	-	4 x 5,0 Ah
Bijgeleverde lader	-	-	DC18RD
Netto gewicht	4,0 kg	4,0 kg	4,0 kg
Gewicht incl. accu en harnas	7,0 kg	7,0 kg	7,0 kg
Prijs in €	excl. btw		
	incl. btw		

	PDC1200	PDC1500
Bestelreferentie	BEAPDC1200A01	EUAPDC1500A01
Accu	Geïntegreerd	Geïntegreerd
Energiecapaciteit	1206 Wh	1567,8 Wh
Bijgeleverde lader	DC4001	DC4001
Laadtijd	6 uur	8 uur
Meegeleverde adapters	2x18V (191J51-5)	-
Gewicht incl. harnas	8,8 kg	13,9 kg
Prijs in €	excl. btw	
	incl. btw	

Accessoire	Ref.	Prijs excl. btw	Prijs incl. btw
Adapter 18V (PDC01)	191J50-7		
Adapter 2 x 18V	191J51-5		
Adapter 40Vmax	191N62-4		
Lader DC4001	191L00-4		

## DHW180Z

ACCU WATERSPUIT 18V

**XPT LXT**

**NIEUW!**



- Eenvoudig in gebruik: de accudrukspuit wordt rechteerks op de watertoevoerslang aangesloten. Geen hogedrukslang of stationaire unit.
- Ideaal voor lichte toepassingen zoals het schoonmaken van de auto, tuinmeublar enz.
- Twee vermogenstanden
- Spuitlans met 5 verschillende sproeistanden en en verlengstuk standaard meegeleverd.
- Het water kan ook vanuit een reservoir opgepompt worden (slang bijgeleverd). Zelfaanzuigend tot diepte van 2 m.
- Gemakkelijk te transporteren en op te bergen.
- Autonomie bij max. vermogen: 30 min (BL1850)

**NIEUW**  
**DHW180Z**

Spanning	18V
Bijgeleverde accu's	-
Lader	-
Werkdruk	24 bar / 8 bar
Werkdebiet	2,5 / 1,5 l/min
Max. aanzuighoogte	2,0 m
Gewicht	2,4 - 2,8 kg
Prijs in €	excl. btw
	incl. btw

## HW001GZ

ACCU HOGEDRUKREINIGER  
40VMAX

**XGT**  
**40Vmax**



### HW001G

- Hoge reinigingskracht met goede balans tussen druk en debiet
- Voeding middels één of twee 40Vmax accu's
- 3 vermogensstanden
- Telescopisch handvat en compartiment voor de accessoires
- Zelfaanzuigend tot 1m diepte (accessoires bijgeleverd)
- Autonomie bij max. vermogen: 18 min (2x BL4050F)

<b>HW001GZ</b>	
Spanning	36V (40Vmax)
Bijgeleverde accu's	-
Lader	-
Werkdruk	30/55/85 bar
Werkdebiet	3,0/4,2/5,5 l/min
Max. aanzuighoogte	1 m
Lengte hogedrukslang	6 m
Gewicht	10,1 - 13,2 kg
Prijs in €	excl. btw
	incl. btw

## DHW080

ACCU HOGEDRUKREINIGER  
2X18V

**18V + 18V** → **36V**

**LXT**



### Compatibel

Er is een breed assortiment aan hulpstukken beschikbaar, ze zijn ook compatibel met de HW1200 / HW1300.

Capaciteit  
watertank  
**50 l**

Werkdruk  
**30/55 bar**

Debiet  
**4,0/5,5 l/min**

**DHW080ZK**

Spanning	2 x 18 V
Bijgeleverde accu's	-
Lader	-
Werkdruk	30/55 bar
Werkdebiet	4,0/5,5 l/min
Inhoud watertank	50 l
Max. aanzuighoogte	1 m
Gewicht	7,1-7,7 kg
Prijs in €	excl. btw
	incl. btw

**US053D / DUS054**

ACCU COMPACTE SPROEIER

- Schoudergedragen model met een 5 l tank
- De twee spuitmonden zijn afzonderlijk te activeren voor small of breed sproeien.
- Uitschuifbare spuitlans: 0,5 – 0,7 m
- Enkel geschikt voor het verwerken van op water gebaseerde gazon- en tuin chemicaliën.



DUS054Z

**CXT LXT XPT**

		DUS053DZ	DUS054Z
Spanning		12Vmax	18V
Bijgeleverde accu's		-	-
Tankinhoud		5 l	5 l
Debiet		0,46-0,6 l/min	0,46-0,6 l/min
Max. druk		3,0 bar	3,0 bar
Afmetingen		340 x 183 x 360 mm	340 x 183 x 360 mm
Gewicht		2,9 - 3,0 kg	3,2 - 3,5 kg
Prijs in €	excl. btw		
	incl. btw		

**DUS108 / DUS158**

ACCU RUGSPROEIERS 18V

- Ruggedragen modellen.
- Standaard geleverd met enkele- en dubbele sproeikop.
- Enkel geschikt voor het verwerken van op water gebaseerde gazon- en tuin chemicaliën.



DUS108Z

DUS158Z

**LXT XPT**

		DUS108Z	DUS158Z
Spanning		18V	18V
Bijgeleverde accu's		-	-
Tankinhoud		10 l	15 l
Debiet		0,8 - 1,3 l/min	0,8 - 1,3 l/min
Max. druk		5,0 bar	5,0 bar
Afmetingen		325 x 237 x 439 mm	325 x 237 x 517 mm
Gewicht		5,6 - 5,9 kg	5,9 - 6,2 kg
Prijs in €	excl. btw		
	incl. btw		

**PF0800 / PF1100**

DOMPELPOMPEN VOOR ZUIVER WATER



PF0800

PF1010

PF1100

PF1110

		PF0800	PF1010	PF1100	PF1110
Nominaal vermogen		800 W	1100 W	1100 W	1100 W
Max. debiet		220 l/min	240 l/min	250 l/min	250 l/min
Max. opvoerhoogte		9 m	10 m	9 m	10 m
Gewicht		6,1 kg	6,6 kg	6,7 kg	7,0 kg
Prijs in €	excl. btw				
	incl. btw				

**PF1010 / PF1110**

DOMPELPOMPEN VOOR VUIJL WATER

**HW1200 / HW1300 / HW131 / HW151**

ELEKTRISCHE HOGEDRUKREINIGERS



HW1300

HW151

HW131

		HW1200	HW1300	HW131	HW151
Vermogen		1800 W	1800 W	2200 W	2500 W
Max. druk		120 bar	130 bar	130 bar	150 bar
Max. debiet		420 l/u	420 l/u	500 l/u	500 l/u
Haspel		10 m	10 m	15 m	10 m
Gewicht		11,0 kg	12,7 kg	33 kg	26,9 kg
Prijs in €	excl. btw				
	incl. btw				



### DUB187

ACCU BLADBLAZER / - ZUIGER 18 V



DUB187T001

#### DUB187Z DUB187T001

Spanning	18V	18V
Bijgeleverde accu's	-	BL1850B
Bijgeleverde lader	-	DC18WC
Luchtsnelheid (blazen)	64 m/s	64 m/s
Max. debiet (zuigen)	6,1 m³/min	6,1 m³/min
Max. onderdruk	33 mbar	33 mbar
Max. blaaskracht	4,2 N	4,2 N
Gewicht	3,7 - 4,0 kg	3,7 - 4,0 kg
Prijs in €	excl. btw	
	incl. btw	

### DUB184

ACCU BLADBLAZER 18 V



DUB184Z

#### DUB184Z DUB184RT

Spanning	18V	18V
Bijgeleverde accu's	-	1 x BL1850B
Bijgeleverde lader	-	DC18RC
Luchtsnelheid	49 m/s	49 m/s
Max. debiet	12,7 m³/min	12,7 m³/min
Max. blaaskracht	10,9 N	10,9 N
Gewicht	2,5 - 3,0 kg	2,5 - 3,0 kg
Prijs in €	excl. btw	
	incl. btw	

### DUB362

ACCU BLADBLAZER 2 x 18 V



DUB362Z

#### DUB362Z DUB362TX1

Spanning	2x18V	2x18V
Bijgeleverde accu's	-	4 x BL1850B
Bijgeleverde lader	-	DC18RD
Luchtsnelheid	54 m/s	54 m/s
Max. debiet	13,4 m³/min	13,4 m³/min
Max. blaaskracht	14,4 N	14,4 N
Gewicht	3,5 - 4,2 kg	3,5 - 4,2 kg
Prijs in €	excl. btw	
	incl. btw	

### UB001G

ACCU BLADBLAZER 40VMAX



#### PROMO

gratis AS001GZ na online registratie UB001GM101



STANDAARD GELEVERD MET PLATTE & RONDE BLAASMOND

#### UB001GZ UB001GM101

Spanning	36V (40Vmax)	36V (40Vmax)
Bijgeleverde accu's	-	1x BL4040
Bijgeleverde lader	-	DC40RA
Luchtsnelheid	64 m/s	64 m/s
Max. debiet	16,0 m³/min	16,0 m³/min
Max. blaaskracht	12 N (17 N boost)	12 N (17 N boost)
Gewicht	3,1 - 3,9 kg	3,1 - 3,9 kg
Prijs in €	excl. btw	
	incl. btw	

### DUB363

ACCU BLADBLAZER / - ZUIGER 2 x 18 V



Geleverd met bladzuigset

#### DUB363ZV

Spanning	2 x 18V
Bijgeleverde accu's	-
Bijgeleverde lader	-
Luchtsnelheid	54 m/s
Max. debiet	13,4 m³/min
Max. blaaskracht	14,4 N
Gewicht	4,5 - 6,6 kg
Prijs in €	excl. btw
	incl. btw

### UB001C / UB003C

BLADBLAZER MET RECHTSTREEKSE AANSLUITING OP ACCUPACK



- UB003C**
- Voor gebruik in combinatie met PDC01, PDC1200 of PDC1500 (directe aansluiting)
  - Levert het hoogste blaasvermogen (24 N) in combinatie met PDC1500
  - Hoge luchtstroom door een verbeterde vorm van de vaste bladen in de turbine
  - Laag gewicht

		UB001CZ	UB003CZ
Platform		PDC	PDC
Max. lichtsnelheid		60 m/s (70 m/s boost)	86 m/s
Max. debiet		15 m <sup>3</sup> /min (17,6 m <sup>3</sup> /min boost)	17,6 m <sup>3</sup> /min
Max. blaaskracht		15 N (20 N boost)	24 N
Autonomie		60 min (20 N, PDC1200)	60 min (24 N, PDC1500)
Gewicht		2,6 kg	2,8 - 3,1 kg
Prijs in €	excl. btw		
	incl. btw		

### UB002CZ / UB004CZ

RUGGEDRAGEN BLADBLAZERS MET RECHTSTREEKSE AANSLUITING OP ACCUPACK



- UB004C**
- Voor gebruik in combinatie met PDC1200 of PDC1500
  - Nieuw ontwerp met de turbine in lijn met de blaaspipij zorgt voor een nog betere efficiëntie. Hoge blaaskracht van 25N en tot 28N in "Boost" modus
  - Drie instelbare maximumsnelheden, trigger met variabele snelheid, cruisecontrol
  - Telescopische blaasmond met traploze afstelling van de lengte en verstelbare greep
  - Uiterst comfortabel harnas



Het accupack kan in één beweging op de machine vastgeklippt worden.



Triggerschakelaar met variabele snelheid en "cruise control" hendel.



De bedieningshendel kan horizontaal verschoven en gekanteld worden.

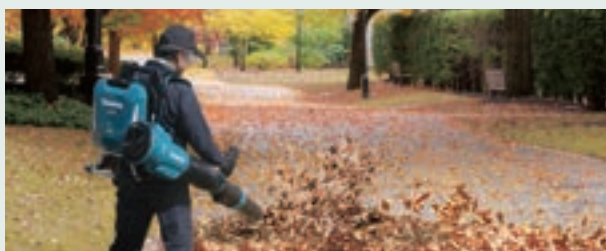

**NIEUW**

		UB002CZ	UB004CZ
Platform		PDC	PDC
Lichtsnelheid		71,7 m/s	76,3 m/s (80,7 m/s Boost)
Max. debiet		19 m <sup>3</sup> /min	19,7 m <sup>3</sup> /min (20,9 m <sup>3</sup> /min Boost)
Max. blaaskracht		22 N	25 N (28 N Boost)
Geluidsdruk niveau		81 dB (A)	82,3 dB(A)
Autonomie		45 min (22 N, PDC1200)	55 min (25 N, PDC1500)
Gewicht		16,1 kg (PDC1200)	16,5 - 18,6 kg (PDC1200-PDC1500)
Prijs in €	excl. btw		
	incl. btw		

## DUX18

ACCU COMBISYSTEEM 18 V



DUX18Z

		DUX18Z	DUX18ZX1
Platform		LXT 18 V	LXT 18 V
Max. afgegeven vermogen		470 W	470 W
Toerental onbelast		0 - 6800 / 0 - 9700 min <sup>-1</sup>	0 - 6800 / 0 - 9700 min <sup>-1</sup>
Bijgeleverde accessoires		-	EM408MP
Bijgeleverde accu's / laders		-	-
Prijs in €	excl. btw		
	incl. btw		

## DUX60

ACCU COMBISYSTEEM  
2 x 18 V



DUX60Z

		DUX60Z	DUX60ZN1	DUX60ZM4	DUX60ZX8
Platform		LXT 2 x 18 V	LXT 2 x 18 V	LXT 2 x 18 V	LXT 2 x 18 V
Max. afgegeven vermogen		600 W	600 W	600 W	600 W
Toerental onbelast		0 - 5700 / 0 - 8200 / 0 - 9700 min <sup>-1</sup>	0 - 5700 / 0 - 8200 / 0 - 9700 min <sup>-1</sup>	0 - 5700 / 0 - 8200 / 0 - 9700 min <sup>-1</sup>	0 - 5700 / 0 - 8200 / 0 - 9700 min <sup>-1</sup>
Bijgeleverde accessoires		-	EN401MP	EM404MP	EN401MP EM404MP
Bijgeleverde accu's / lader		-	-	-	-
Prijs in €	excl. btw				
	incl. btw				

## COMBISYSTEEM OPZETSTUKKEN

Artikel	Referentie	Zwaard- lengte Ø (mm)	Prijs excl. btw	Prijs incl. btw
BOSMAAIER (Voor DUX18 enkel EM408MP geschikt)				
EM404MP	198768-1	450 mm		
EM401MP	195888-2	300 mm		
EM400MP	195648-2	420 mm		
EM406MP	198779-6	420 mm		
EM408MP	191N31-5	300 mm		
ROTORSCHAAR				
EM407MP	191M56-3			
GRASTRIMMER				
ER400MP	195522-4	410 mm		
SNOEIKETTINGZAAG				
EY403MP	191T38-7	30 cm		
STOKHEGGENSCHAAR				
EN401MP	196256-2			
EN410MP	197726-4			
EN402MP	1912T8-8			
EN422MP	1912T0-4			
GRONDFREES				
KR400MP	199181-6			
BOORDENSNIJDER				
EE400MP	196752-0			
VERLENGSTUK				
LE400MP	191E24-8			
ROLVEGER				
SW400MP	199339-7			
ROLBORSTEL				
BR400MP	199318-5			
BLAZER				
UB401MP	191P72-3			
UB402MP	1912R8-4			
WATERPOMP				
PF400MP	DEAPF400MP			
SCHOFFEL				
<b>NIEUW</b> WA400MP	1913P8-6			
MAAIBALK				
EN424MP	1913C9-3			

## UX01GZ

ACCU COMBISYSTEEM 40VMAX



		UX01GZ	UX01GZ01
Platform		XGT 40Vmax	XGT 40Vmax
Max. afgegeven vermogen		1000 W	1000 W
Toerental onbelast		0 - 5700 / 0 - 8200 / 0 - 9700 min <sup>-1</sup>	0 - 5700 / 0 - 8200 / 0 - 9700 min <sup>-1</sup>
Bijgeleverde accessoires		-	EM404MP
Bijgeleverde accu's / laders		-	-
Prijs in €	excl. btw		
	incl. btw		



**DDG460 / DDG461**  
 ACCU GRONDBOOR 2 x 18 V

**LXT ADT BL MOTOR XPT**

**18V+18V → 36V**



DDG460Z7



DDG461Z

DDG460 is uitgerust met boorkop; voor het aansluiten van een grondboor is een adapter nodig (Type "D" voor Makita grondboren, Type "A" voor Stihl grondboren). De DDG461 daarentegen heeft een as-gat opname waar de Makita grondboren rechtstreeks op passen.



Boorkop aansluiting      Rechtstreekse aansluiting



	DDG460Z7	DDG460T2X7	DDG461Z
Spanning	2 x 18 V	2 x 18 V	36 V (40Vmax)
Bijgeleverde accu's	-	2x BL1850B	-
Bijgeleverde lader	-	DC18RD	-
Max. diameter boor	200 mm	200 mm	200 mm
Opname	Boorkop	Boorkop	Directe aansluiting
Max. koppel	136 Nm	136 Nm	136 Nm
Toerental onbelast	0 - 350 min <sup>-1</sup> 0 - 1400 min <sup>-1</sup>	0 - 350 min <sup>-1</sup> 0 - 1400 min <sup>-1</sup>	0 - 350 min <sup>-1</sup> 0 - 1400 min <sup>-1</sup>
Gewicht	7,3 - 8,2 kg	7,3 - 8,2 kg	7,0 - 7,6 kg
Prijs in €	excl. btw		
	incl. btw		



**Omkeerschakelaar**

De draairichting kan omgekeerd worden om de boor los te maken wanneer ze geblokkeerd geraakt is of te diep vastzit in zware kleigrond.



**Slipkoppeling**

De slipkoppeling verbreekt de verbinding tussen de motor en de boor wanneer het koppel een extreme waarde overschrijdt. Dat voorkomt schade aan de machine en verhoogt de veiligheid voor de gebruiker.

**DG001G / DG002G**  
 ACCU GRONDBOOR 40VMAX

**ADT BL MOTOR XPT XGT 40Vmax**

**PROMO**

gratis AS001GZ na online registratie DG001GM105

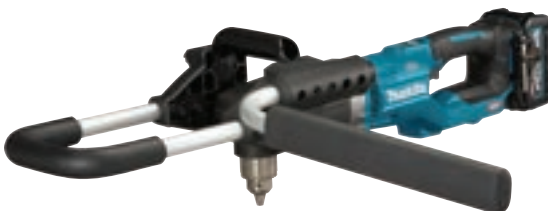

DG001GM105

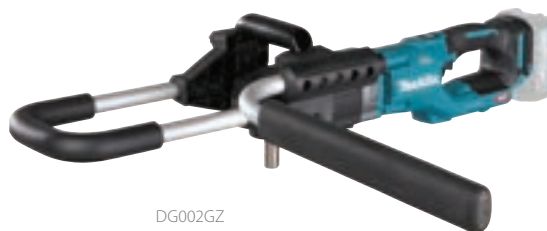

DG002GZ



DG001G is uitgerust met boorkop. Voor het aansluiten van een grondboor is een adapter nodig. (Type D voor Makita grondboren, type A voor Stihl grondboren) De DG002G heeft een as-gat opname waar de Makita grondboren rechtstreeks op passen.



Boorkop aansluiting      Rechtstreekse aansluiting

	DG001GZ05	DG001GM105	DG002GZ
Spanning	36V (40Vmax)	36V (40Vmax)	36V (40Vmax)
Bijgeleverde accu's	-	1x BL4040	-
Bijgeleverde lader	-	DC40RA	-
Max. diameter boor	200 mm	200 mm	200 mm
Opname	Boorkop	Boorkop	Directe opname
Max. koppel	136 Nm	136 Nm	136 Nm
Toerental onbelast	0 - 350 min <sup>-1</sup> 0 - 1400 min <sup>-1</sup>	0 - 350 min <sup>-1</sup> 0 - 1400 min <sup>-1</sup>	0 - 350 min <sup>-1</sup> 0 - 1400 min <sup>-1</sup>
Gewicht	7,2 - 8,1 kg	7,2 - 8,1 kg	7,2 - 8,1 kg
Prijs in €	excl. btw		
	incl. btw		

### UP100D

SNOEISCHAAR 12VMAX



#### UP100D - DUP180Z

- Uiterst licht en smalle greep dankzij ultracompacte BL motor zonder metalen kern
- Werkt zeer comfortabel dankzij servosturing (de schaar volgt exact de beweging van de trigger)
- De bladopeningshoek kan in verschillende posities ingesteld worden afhankelijk van de dikte van de takken, dit werkt tijdbesparend.
- **DUP180:** versie voor LXT accu's, met batterijadapter die aan de heup bevestigd wordt en een kabel naar de snoeischaar.
- **UP100D:** versie voor CXT accu's, de accu zit achteraan op de snoeischaar. Bijzonder geschikt voor fijn snoeiwerk.



#### UP100DSMJ

Spanning	10,8 V
Bijgeleverde accu's	1x BL1041B
Bijgeleverde lader	DC10SB
Maximaal afgegeven vermogen	170 W
Afmetingen (L x B x H)	259 x 53 x 98 mm
Gewicht	0,89 - 1,1 kg
Prijs in €	excl. btw
	incl. btw

### DUP180

ACCU SNOEISCHAAR 18V



#### DUP180Z



De bladopeningshoek kan in verschillende posities ingesteld worden

Spanning	18 V
Bijgeleverde accu's	-
Bijgeleverde lader	-
Maximaal afgegeven vermogen	370 W
Snijcapaciteit	30 mm
Afmetingen (L x B x H)	296 x 40 x 99 mm
Gewicht	0,68 kg
Prijs in €	excl. btw
	incl. btw

### DUP362

ACCU SNOEISCHAAR 2 x 18 V



**Inclusief**  
harnas & holster

#### DUP362Z

#### DUP362PT2

Bijgeleverde accu's	-	2 x accu 5,0 Ah
Bijgeleverde lader	-	DC18RD
Snijcapaciteit	33 mm	33 mm
Gewicht	3,3 kg	3,3 kg
Prijs in €	excl. btw	
	incl. btw	

### UD2500

ELEKTRISCHE HAKSELAAR



#### UD2500

Nominaal vermogen	2500 W
Max. toerental onbelast	40 t.p.m
Max. takdikte	45 mm
Geluidsdruk	84 dB(A)
Gewicht	29,7 kg
Prijs in €	excl. btw
	incl. btw

### DCU180Z

ACCU KRUIWAGEN 18 V



Elektronische snelheidsregeling



Demonteerbare achterwielen



Geïntegreerde ledverlichting



**PROMO**

GRATIS BUIZENFRAME  
(199009-8)

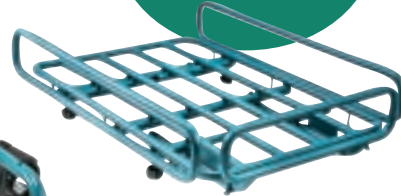

#### DCU180Z

Spanning	18 V
Rijsnelheid	0 - 3,5 km/u
Draagvermogen	130 kg
Max. helling	12°
Gewicht	39.3 - 44.8 kg
Prijs in €	excl. btw
	incl. btw

### DCU603 / DCU604 / DCU605 / DCU601 / DCU602

ACCU TRANSPORTERS 2 x 18 V



DCU603

Met kuip en manuele kiepfunctie



DCU605

Met vaste, vlakke kuip



DCU604

Met frame en manuele kiepfunctie



DCU601

Plateau met elektrische lift



DCU602

Met kuip en elektrische kiepfunctie



#### DCU601Z

- Transporter met elektrohydraulische lift
- Ideaal voor het optillen van zware lasten om bijvoorbeeld over te laden in een bestelwagen of aanhangwagen
- De zijsteunen kunnen verlaagd worden tot onder het platform
- Maximum hefcapaciteit 300 kg



#### DCU602Z

- Dumper met elektrohydraulische kiepfunctie
- De laadbak kan elektrisch worden gekiept tot 75° en handmatig tot 110°.
- Maximum hefcapaciteit 300 kg

	DCU603Z	DCU604Z	DCU605Z	DCU601Z	DCU602Z
Spanning	2 x 18V	2 x 18V	2 x 18V	2 x 18V	2 x 18V
Type	Kantelbare kuip	Kantelbaar frame	Vaste kuip	Plateau met elektrische lift	Elektrisch kantelbare kuip
Volume kuip	100 l	-	250 l	-	100 l
Max. lading vlak terrein	300 kg	300 kg	300 kg	300 kg	300 kg
Max. lading helling (3° - 12°)	180 kg	180 kg	180 kg	180 kg	180 kg
Rijsnelheid vooruit	1,5 - 3,5 - 5,0 km/h	1,5 - 3,5 - 5,0 km/h	1,5 - 3,5 - 5,0 km/h	1,5 - 3,5 - 5,0 km/h	1,5 - 3,5 - 5,0 km/h
Rijsnelheid achteruit	1,0 km/h	1,0 km/h	1,0 km/h	1,0 km/h	1,0 km/h
Gewicht	122 - 124 kg	122 - 124 kg	122 - 124 kg	145 kg	147 kg
Prijs in €	excl. btw				
	incl. btw				



## UM600D / DUM111 / DUM604

ACCU GRAS- EN HEGGENSCHAREN

### PROMO

Gratis opbergtas bij UM600DSAEX, DUM111SYX en DUM604RFEX



DUM604RFEX



DUM111SYX

	UM600DSAEX	DUM111SYX	DUM604RFEX	DUM604ZX
Spanning	10,8 V (12Vmax)	18 V	18 V	18 V
Bijgeleverde accu's	2 x accu 2,0 Ah	1 x accu 1,5 Ah	2 x accu 3,0 Ah	-
Lader	DC10SB	DC18SD	DC18RC	-
Snijlengte heggenschaar	20 cm	20 cm	20 cm	20 cm
Snijbreedte grasschaar	16 cm	11 cm	16 cm	16 cm
Maximale takdikte	8 mm	-	10 mm	10 mm
Geleverd met	Grasschaar + Heggenschaar	Grasschaar + Heggenschaar	Grasschaar + Heggenschaar	Grasschaar + Heggenschaar
Gewicht	1,2 kg	1,8 kg	1,8 kg	1,8 kg
Prijs in €	excl. btw			
	incl. btw			

## DUH507 / DUH607

ACCU HEGGENSCHAREN 18V



DUH607Z

### DUH507 & DUH607:

- Budgetvriendelijke versies
- Compact en uiterst licht
- Versterkt krukmechanisme
- Handgreep met nieuw ontworpen schakelaar
- Hoogwaardige trillingsdemping

	DUH507Z	DUH507F001	DUH607Z	DUH607F001
Spanning	18V	18V	18V	18V
Bijgeleverde accu's	-	1x accu 3,0 Ah	-	1x accu 3,0 Ah
Bijgeleverde lader	-	DC18WC	-	DC18WC
BL motor	-	-	-	-
Snijlengte	50 cm	50 cm	60 cm	60 cm
Maximale takdikte	15 mm	15 mm	15 mm	15 mm
Aantal snijbewegingen	2700 min <sup>-1</sup>	2700 min <sup>-1</sup>	2700 min <sup>-1</sup>	2700 min <sup>-1</sup>
Max. uitgangsvermogen	250 W	250 W	250 W	250 W
Gewicht	2,7 - 3,0 kg	2,7 - 3,0 kg	2,8 - 3,1 kg	2,8 - 3,1 kg
Prijs in €	excl. btw			
	incl. btw			

## DUH506 / DUH606

ACCU HEGGENSCHAREN 18 V



DUH606RF

### DUH506 & DUH606:

- Zeer efficiënt dankzij BL motor
- Compact en uiterst licht
- Versterkt krukmechanisme
- Handgreep met nieuw ontworpen schakelaar
- Hoogwaardige trillingsdemping

	DUH506Z	DUH506RF	DUH606Z	DUH606RF
Spanning	18V	18V	18V	18V
Bijgeleverde accu's	-	1x accu 3,0 Ah	-	1x accu 3,0 Ah
Bijgeleverde lader	-	DC18RC	-	DC18RC
BL motor	✓	✓	✓	✓
Snijlengte	50 cm	50 cm	60 cm	60 cm
Max. takdikte	20 mm	20 mm	20 mm	20 mm
Aantal snijbewegingen	4000 min <sup>-1</sup>	4000 min <sup>-1</sup>	4000 min <sup>-1</sup>	4000 min <sup>-1</sup>
Max. uitgangsvermogen	320 W	320 W	320 W	320 W
Gewicht	2,5 - 2,9 kg	2,5 - 2,9 kg	2,7 - 3,0 kg	2,7 - 3,0 kg
Prijs in €	excl. btw			
	incl. btw			

## DUH502 / DUH602 / DUH752

ACCU HEGGENSCHAREN 18 V



TANDEN MET KLASIEKE GEOMETRIE



DUH502RT

	DUH502Z	DUH502RT	DUH602Z	DUH602RT	DUH752Z	DUH752RT
Spanning	18V	18V	18V	18V	18V	18V
Bijgeleverde accu's	-	1 x accu 5,0 Ah	-	1 x accu 5,0 Ah	-	1 x accu 5,0 Ah
Bijgeleverde lader	-	1 x DC18RC	-	1 x DC18RC	-	1 x DC18RC
BL motor	✓	✓	✓	✓	✓	✓
Snijlengte	50 cm	50 cm	60 cm	60 cm	75 cm	75 cm
Max. takdikte	21,5 mm	21,5 mm	21,5 mm	21,5 mm	21,5 mm	21,5 mm
Aantal snijbewegingen	2000 / 3600 / 4400 min <sup>-1</sup>	2000 / 3600 / 4400 min <sup>-1</sup>	2000 / 3600 / 4400 min <sup>-1</sup>	2000 / 3600 / 4400 min <sup>-1</sup>	2000 / 3600 / 4400 min <sup>-1</sup>	2000 / 3600 / 4400 min <sup>-1</sup>
Max. uitgangsvermogen	520 W	520 W	520 W	520 W	520 W	520 W
Gewicht	3,8 kg	3,8 kg	3,8 kg	3,8 kg	3,8 kg	3,8 kg
Prijs in €	excl. btw					
	incl. btw					

## DUH501 / DUH601 / DUH751 / DUH754S

ACCU HEGGENSCHAREN 18 V

**PROMO**

gratis DMR057 na online registratie DUH501RTE



TANDEN MET INNOVATIEVE GEOMETRIE



DUH501RTE



DUH754S  
(ENKELZIJDIG MES)

**INNOVATIEVE GEOMETRIE**

Beter snijresultaat  
Minder wrijving  
Grotere batterijautonomie

	DUH501Z	DUH501RTE	DUH601Z	DUH601PTE	DUH751Z	DUH751PTE	DUH754SZ
Uitvoering	Trim	Trim	Trim	Trim	Trim	Trim	Trim
Mes	Dubbelzijdig	Dubbelzijdig	Dubbelzijdig	Dubbelzijdig	Dubbelzijdig	Dubbelzijdig	Enkelzijdig
Bijgeleverde accu's	-	2 x accu 5,0 Ah	-	2 x accu 5,0 Ah	--	2 x accu 5,0 Ah	-
Bijgeleverde Lader	-	1 x DC18RC	-	1 x DC18RD	-	1 x DC18RD	-
BL motor	✓	✓	✓	✓	✓	✓	✓
Aantal snijbewegingen	2000/3600/4400 min <sup>-1</sup>	2000/3600/4400 min <sup>-1</sup>	2000/3600/4400 min <sup>-1</sup>	2000/3600/4400 min <sup>-1</sup>	2000/3600/4400 min <sup>-1</sup>	2000/3600/4400 min <sup>-1</sup>	2000/3600/4400 min <sup>-1</sup>
Snijlengte	50 cm	50 cm	60 cm	60 cm	75 cm	75 cm	75 cm
Max. takdikte	23,5 mm	23,5 mm	23,5 mm	23,5 mm	23,5 mm	23,5 mm	23,5 mm
Max. uitgangsvermogen	520 W	520 W	520 W	520 W	520 W	520 W	520 W
Gewicht	3,8 - 4,5 kg	3,8 - 4,5 kg	3,8 - 4,5 kg	3,8 - 4,5 kg	3,8 - 4,5 kg	3,8 - 4,5 kg	3,4 - 3,9 kg
Prijs in €	excl. btw						
	incl. btw						

## UH020GZ / UH021GZ

ACCU HEGGENSCHAREN 40VMAX

### UH020G-UH021G

- Uiterst lichte machine, dit maakt het werk veel minder vermoeiend.
- Ideaal voor het trimmen van fijne hagen (dunnere takken)
- Uitgerust met sterke BL motor, voeding met XGT 40Vmax accu
- Compact waardoor deze gemakkelijk te hanteren is, ook bij heggen met veel gebogen oppervlakken.
- Driezijdig geslepen tanden voor een optimaal snijresultaat
- Omkeerfunctie voor gemakkelijk deblokkeren van het mes



UH021GZ

	NIEUW	
	UH020GZ	UH021GZ
Uitvoering	Trim	Trim
Mes	Dubbelzijdig	Dubbelzijdig
Bijgeleverde accu's	-	-
Bijgeleverde lader	-	-
Aantal snijbewegingen	4200 min <sup>-1</sup>	4200 min <sup>-1</sup>
Snijlengte	50 cm	60 cm
Max. takdikte	20 mm	20 mm
Max. uitgangsvermogen	460 W	460 W
Gewicht	3,0 - 4,2 kg	3,0 - 4,2 kg
Prijs in €	excl. btw	
	incl. btw	

## UH004G / UH005G

ACCU HEGGENSCHAREN 40VMAX 'TRIMVERSIE'

**PROMO**

gratis AS001GZ na online registratie UH004GM201 & UH005GM201



UH004GM201

	UH004GZ	UH004GM201	UH005GZ	UH005GM201
Uitvoering	Trim	Trim	Trim	Trim
Mes	Dubbelzijdig	Dubbelzijdig	Dubbelzijdig	Dubbelzijdig
Bijgeleverde accu's	-	2x BL4040	-	2x BL4040
Bijgeleverde lader	-	DC40RA	-	DC40RA
Aantal snijbewegingen	2000/3600/ 5000 min <sup>-1</sup>	2000/3600/ 5000 min <sup>-1</sup>	2000/3600/ 5000 min <sup>-1</sup>	2000/3600/ 5000 min <sup>-1</sup>
Snijlengte	60 cm	60 cm	75 cm	75 cm
Max. takdikte	23,5 mm	23,5 mm	23,5 mm	23,5 mm
Max. uitgangsvermogen	720 W	720 W	720 W	720 W
Gewicht	4,3 - 4,9 kg	4,3 - 4,9 kg	4,5 - 5,1 kg	4,5 - 5,1 kg
Prijs in €	excl. btw			
	incl. btw			

## UH006G / UH007G

ACCU HEGGENSCHAREN 40VMAX 'TERUGSNOEIVERSIE'

**PROMO**

gratis AS001GZ na online registratie UH006GM201 & UH007GM201

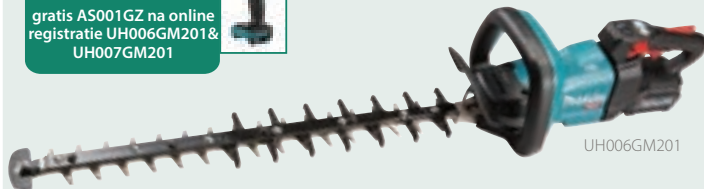

UH006GM201

	UH006GZ	UH006GM201	UH007GZ	UH007GM201
Uitvoering	Terugsnoei	Terugsnoei	Terugsnoei	Terugsnoei
Mes	Dubbelzijdig	Dubbelzijdig	Dubbelzijdig	Dubbelzijdig
Bijgeleverde accu's	-	2x BL4040	-	2x BL4040
Bijgeleverde lader	-	DC40RA	-	DC40RA
Aantal snijbewegingen	2000/3000/ 4000 min <sup>-1</sup>	2000/3000/ 4000 min <sup>-1</sup>	2000/3000/ 4000 min <sup>-1</sup>	2000/3000/ 4000 min <sup>-1</sup>
Snijlengte	60 cm	60 cm	75 cm	75 cm
Max. takdikte	25 mm	25 mm	25 mm	25 mm
Max. uitgangsvermogen	720 W	720 W	720 W	720 W
Gewicht	4,4 - 5,0 kg	4,4 - 5,0 kg	4,6 - 5,2 kg	4,6 - 5,2 kg
Prijs in €	excl. btw			
	incl. btw			





## UN460W

ACCU STOKHEGGENSCHAREN (CXT)



UN460W

### UN460WDZ UN460WDWA

Spanning	10,8V (12Vmax)	10,8V (12Vmax)
Bijgeleverde accu's	-	1 x accu 2,0 Ah
Bijgeleverde lader	-	DC10WD
Snijlengte	46 cm	46 cm
Maximale takdikte	18 mm	18 mm
Totale lengte	1,889 - 2,511mm	1,889 - 2,511mm
BL motor	-	-
Aantal snijbewegingen	3600 min <sup>-1</sup>	3600 min <sup>-1</sup>
Omkeerfunctie	✓	✓
Gewicht	2,8 -3,0 kg	2,8 - 3,0 kg
Prijs in €	excl. btw	
	incl. btw	

## DUN461 / DUN500

ACCU STOKHEGGENSCHAREN 18V

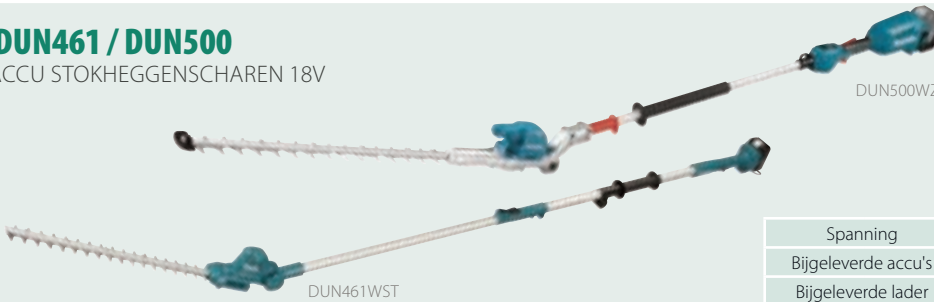

DUN461WST

DUN500WZ

### DUN461WZ DUN461WST DUN500WZ

Spanning	18V	18V	18V
Bijgeleverde accu's	-	1 x accu 5,0 Ah	-
Bijgeleverde lader	-	DC18SD	-
Snijlengte	46 cm	46 cm	50 cm
Maximale takdikte	18 mm	18 mm	23,5 mm
Totale lengte	1,889 - 2,511mm	1,889 - 2,511mm	2,115 mm
BL motor	-	-	✓
Aantal snijbewegingen	3600 min <sup>-1</sup>	3600 min <sup>-1</sup>	2000/3600/ 4400 min <sup>-1</sup>
Omkeerfunctie	✓	✓	✓
Gewicht	3,0 - 3,3 kg	3,4 kg	3,9 - 4,3 kg
Prijs in €	excl. btw		
	incl. btw		

### DUN500WZ

- Instelbaar in 6 hoeken
- Dubbele greep voor extra comfort
- Innovatieve tandengeometrie
- Totale lengte: 2,1m

### DUN461

- Klassieke tandengeometrie
- Telescopische steel 1,9 m en 2,5 m

## UN001GZ

ACCU STOKHEGGENSCHAREN 40VMAX

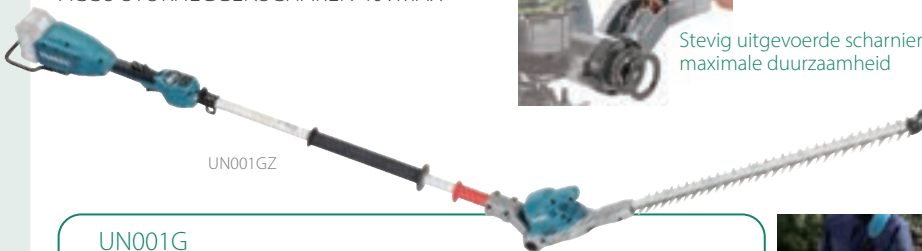

UN001GZ



Stevig uitgevoerde scharnier voor maximale duurzaamheid

### UN001G

- Krachtige stokheggenschaar met een vermogen vergelijkbaar met dat van benzinemodellen, maar toch ook de lichtste in deze klasse.
- Hoekverstelbare kop; 45° omhoog kantelen tot 70° omlaag kantelen vanuit de horizontale positie. Kan 180° gekanteld worden voor gemakkelijk transport.
- Zwaar uitgevoerde messen om ook dikkere takken te kunnen knippen (terugsnoeiversie).
- Dubbelzijdig geslepen messen en tanden met 3 geslepen zijden.
- De motor is in lijn met het mes geplaatst voor een optimale balans.



### NIEUW UN001GZ

Spanning	36V (40Vmax)
Bijgeleverde accu's	-
Bijgeleverde lader	-
Snijlengte	60 cm
Maximale takdikte	25 mm
Totale lengte	2268 mm
BL motor	✓
Aantal snijbewegingen	4000 min <sup>-1</sup>
Omkeerfunctie	✓
Gewicht	4,7 - 5,9 kg
Prijs in €	excl. btw
	incl. btw

**DLM330 ACCU GRASMAAIERS 18 V**



- Licht en compact
- Kan verticaal gestockeerd worden
- Ideaal voor kleine oppervlaktes



DLM330SM

	DLM330Z	DLM330SM
Spanning	1 x 18V	1 x 18V
Bijgeleverde accu's	-	1 x accu 4,0 Ah
Bijgeleverde Lader	-	DC18SD
Max. uitgangsvermogen	450 W	450 W
Maaibreedte	33 cm	33 cm
Aanbevolen terreinoppervlakte	200 - 450 m <sup>2</sup>	200 - 450 m <sup>2</sup>
Inhoud opvangbak	30 l	30 l
Chassis	Polypropyleen	Polypropyleen
Zelftrekkend	-	-
Mulching	✓	✓
Gewicht	11,6 - 12,5 kg	11,6 - 12,5 kg
Prijs in €	excl. btw	
	incl. btw	

**DLM432 ACCU GRASMAAIERS 2 x 18 V**



DLM432PT2

	DLM432Z	DLM432PT2
Spanning	2 x 18V	2 x 18V
Bijgeleverde accu's	-	2 x accu 5,0 Ah
Bijgeleverde Lader	-	DC18RD
Max. uitgangsvermogen	900 W	900 W
Maaibreedte	43 cm	43 cm
Aanbevolen terreinoppervlakte	300 - 575 m <sup>2</sup>	300 - 575 m <sup>2</sup>
Inhoud opvangbak	50 l	50 l
Chassis	Polypropyleen	Polypropyleen
Zelftrekkend	-	-
Mulching	Optioneel	Optioneel
Gewicht	14,3 kg	14,3 kg
Prijs in €	excl. btw	
	incl. btw	

**AANBEVOLEN  
MAAIOPPERVLAKTE**

De aanbevolen maaioffervlakte is de oppervlakte waar de machine qua vermogen, mechaniek en werkbreedte voor geschikt is. Opgelet, dit komt niet noodzakelijk overeen met de autonomie, die afhankelijk is van het type batterijen dat gebruikt wordt en de maaiomstandigheden (de hoogte en dichtheid van het gras, de helling van het terrein enz.) Dus het kan voorkomen dat de accu's tussenin bijgeladen moeten worden om de volledige oppervlakte te kunnen maaien.

**DLM480 / DLM481 / DLM539 ACCU GRASMAAIERS 2 x 18 V**



**Promo!**

Gratis accu 5 Ah BL1850B na online registratie DLM481CT2 & DLM539CT2



DLM539CT2

DLM481CT2

	DLM480CT2	DLM481CT2	DLM539CT2
Spanning	2 x 18V	2 x 18V	2 X 18V
Bijgeleverde accu's	2 x accu 5,0 Ah	2 x accu 5,0 Ah	2 x accu 5,0 Ah
Bijgeleverde Lader	DC18SH	DC18SH	DC18SH
Max. uitgangsvermogen	860 W	860 W	860 W
Maaibreedte	48 cm	48 cm	53,4 cm
Aanbevolen terreinoppervlakte	400 - 800 m <sup>2</sup>	400 - 800 m <sup>2</sup>	500 - 1000 m <sup>2</sup>
Inhoud opvangbak	62 l	62 l	70 l
Chassis	Polypropyleen	Polypropyleen	Polypropyleen
Zelftrekkend	-	✓	✓
Mulching	✓	✓	✓
Prijs in €	excl. btw		
	incl. btw		

**DLM463 / DLM465 ACCU GRASMAAIERS 2 x 18 V**

18V + 18V → 36V

XPT  
EXTREME PROTECTION TECHNOLOGY

BL  
MOTOR

**Promo!**

Gratis accu 5 Ah  
BL1850B na online  
registratie



DLM463PT2

DLM465PT2

	DLM463Z	DLM463PT2	DLM465Z	DLM465PT2
Spanning	2x 18V	2x 18V	2x 18V	2x 18V
Bijgeleverde accu's	-	DC18RD	-	2x 5,0 Ah
Bijgeleverde Lader	-	2x 5,0 Ah	-	DC18RD
Max. uitgangsvermogen	1450 W	1450 W	1600 W	1600 W
Maaibreedte	46 cm	46 cm	46 cm	46 cm
Aanbevolen terreinoppervlakte	800 - 1600 m <sup>2</sup>	800 - 1600 m <sup>2</sup>	1600 - 1800 m <sup>2</sup>	1600 - 1800 m <sup>2</sup>
Inhoud opvangbak	60 l	60 l	60 l	60 l
Chassis	Staal	Staal	Staal	Staal
Zelftrekkend	-	-	✓	✓
Mulching	✓	✓	✓	✓
Gewicht	25,3 - 27,6 kg	25,3 - 27,6 kg	35,3 - 39,0 kg	35,3 - 39,0 kg
Prijs in €	excl. btw			
	incl. btw			

**DLM536 / DLM533 ACCU GRASMAAIERS 2 x 18 V**

18V + 18V → 36V

XPT  
EXTREME PROTECTION TECHNOLOGY

BL  
MOTOR

**Promo!**

Gratis accu 5 Ah  
BL1850B na online  
registratie



DLM536Z

DLM533Z

	DLM536Z	DLM533Z
Spanning	2x 18V	2x 18V
Bijgeleverde accu's	-	-
Bijgeleverde Lader	-	-
Max. uitgangsvermogen	1600 W	1600 W
Maaibreedte	53 cm	53 cm
Aanbevolen terreinoppervlakte	1600 - 1800 m <sup>2</sup>	1600 - 1800 m <sup>2</sup>
Inhoud opvangbak	Staal	Aluminium
Chassis	✓	✓
Zelftrekkend	60 l	60 l
Mulching	✓	✓
Gewicht	39,0 - 42,8 kg	39,0 - 42,8 kg
Prijs in €	excl. btw	
	incl. btw	





LM003G / LM004G ACCU GRASMAAIER 40VMAX



**PROMO**

Gratis BL4040 na online registratie LM003GM102 en LM004GM102



LM003GM102



LM004GM102



Plaatsbesparend verticaal opbergen

- LM003G & LM004G**
- Budgetvriendelijk model met één 40Vmax accu
  - Kunststof maaidek
  - Gemakkelijk te bedienen schakelhendel met lichte veer
  - Hoogteregeling in 10 stappen
  - Verbeterde grasopvang, standaard geleverd met mes voor zowel opvangen als mulchen
  - De duwhendel kan gemakkelijk ontgrendeld en opgeplooid worden
  - Kan zeer compact verticaal gestockeerd worden
  - Mulchplug inbegrepen
  - Speciaal mes geoptimaliseerd voor mulchen in optie verkrijgbaar

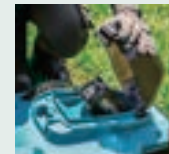

Werkt met één 40Vmax accu



Centrale hoogteregeling

	LM003GZ	LM003GM102	LM004GZ	LM004GM102
Spanning	36 V (40Vmax)	36 V (40Vmax)	36 V (40Vmax)	36 V (40Vmax)
Bijgeleverde accu's	-	1x BL4040	-	1x BL4040
Bijgeleverde lader	-	DC40RA	-	DC40RA
Max. uitgangsvermogen	740 W	740 W	740 W	740 W
Maaibreedte	380 mm	380 mm	430 mm	430 mm
Aanbevolen terreinoppervlakte	75 - 780 m <sup>2</sup>	75 - 780 m <sup>2</sup>	100 - 830 m <sup>2</sup>	100 - 830 m <sup>2</sup>
Toerental onbelast	3800 min <sup>-1</sup>	3800 min <sup>-1</sup>	3800 min <sup>-1</sup>	3800 min <sup>-1</sup>
Maaihogte	20 - 70 mm	20 - 70 mm	20 - 70 mm	20 - 70 mm
Opvangcapaciteit	40 l	40 l	50 l	50 l
Mulching	✓	✓	✓	✓
Chassis	Polypropyleen	Polypropyleen	Polypropyleen	Polypropyleen
Gewicht	14,9 - 17,3 kg	14,9 - 17,3 kg	15,6 - 18,2 kg	15,6 - 18,2 kg
Prijs in €	excl. btw			
	incl. btw			

LM001G / LM002G ACCU GRASMAAIERS 40VMAX



**PROMO**

Gratis BL4040 direct geleverd bij LM001GZ & LM002GZ



LM001G

	LM001GZ	LM002GZ
Spanning	36 V (40Vmax)	36 V (40Vmax)
Max. uitgangsvermogen	1900 W	1900 W
Maaibreedte	48 cm	53 cm
Aanbevolen terreinoppervlakte	1600 - 1800 m <sup>2</sup>	1700 - 2000 m <sup>2</sup>
Toerental onbelast	2500 / 3200 min <sup>-1</sup>	2300 / 2800 min <sup>-1</sup>
Maaihogte	20 - 100 mm	20 - 100 mm
Rijsnelheid	1,5 - 5,0 km/h	1,5 - 5,0 km/h
Opvangcapaciteit	62 l	70 l
Gewicht	28,0 - 33,0 kg	29,5 - 34,7 kg
Prijs in €	excl. btw	
	incl. btw	

**UV001G**  
**ACCU VERTICUTEERMACHINE**  
**40VMAX**



Hoogteregeling Compact opbergen



De moshark is een cilinder met fijne metalen pinnen die het gras uitkamt zonder insnijdingen te maken in de bodem. Wordt gebruikt om oud gras en mos (de viltlaag) uit het gras te verwijderen. Daardoor krijgt het gras meer licht en lucht.



Het verticuteermes wordt gebruikt om de oppervlakte wortels door te snijden hetgeen de groei stimuleert en om de water- en luchtfiltratie te verbeteren.



- Uitgerust met krachtige BL motor op 40Vmax
- Werkt met één of twee XGT accu's, het overschakelen gaat automatisch (accu's niet mee geleverd)
- De werkdiepte is met één knop in te stellen van -12 tot 5 mm, 18 stappen
- Standaard geleverd met verticuteerrol en een accessoire voor het ontmossen zonder snijden (moshark)
- De messen met hoge duurzaamheid zijn speciaal ontworpen om lang scherp te blijven
- Zeer trillingsarm door symmetrische uitlijning van de messen en het gebruik van tegengewichten
- Inklapbare handgreep, de machine kan zeer compact opgeborgen worden
- Het kunststof onderdek mag met water afgespoeld worden voor het gemakkelijk reinigen

**UV001GZ**

Spanning	36 V (40Vmax)
Max. uitgangsvermogen	1700 W
Werkbreedte	380 mm
Werkdiepte	-5 tot -12 mm
Capaciteit opvang	50 l
Gewicht	18,7 - 23,8 kg
Prijs in €	excl. btw
	incl. btw

**UV3200 / UV3600**  
**ELEKTRISCHE VERTICUTEERMACHINES**



UV3200

UV3600

	UV3200	UV3600
Nominaal vermogen	1300 W	1800 W
Werkbreedte	32 cm	36 cm
Polypropyleen chassis	✓	✓
Gewicht	15 kg	18,3 kg
Prijs in €	excl. btw	
	incl. btw	

**Accessoires voor verticuteerders - verluchters**

	Ref.	Lengte	Geschikt voor model	Standaard meegeleverd	Prijs euro excl. btw	Prijs euro incl. btw
	Complete verticuteerrol voor UV3200					
	652024718	320 mm	UV3200	✓		
	Complete verluchterrol voor UV3200					
	652024719	320 mm	UV3200			
	Complete verticuteerrol voor UV3600					
	652024746	360 mm	UV3600	✓		
	Complete verluchterrol voor UV3600					
	652024750	360 mm	UV3600			
	Gecombineerde rol om te verluchten en verticuteren voor UV3600					
	652024749	360 mm	UV3600			
	Verticuteerrol UV001G					
	1913J5-0	380 mm	UV001G	✓		
	Moshark UV001G					
	1913J7-6	380 mm	UV001G	✓		



DUC353Z DUC405Z

DUR368LZ

DUR190UT11

DUR369AZ



DUR368AZ



DUC405Z

DLM481CT2

DLM539CT2

DLM463Z

DLM536Z

DLM463PT2

DLM537Z

DLM465Z

DLM539CT2

DLM465PT2



**PROMO**  
BL1850B  
1 accu 5,0 Ah gratis na online registratie  
Bij aankoop van een LXT machine



Z-versies  
geleverd zonder  
batterijen of lader

Promo: gratis artikelen direct geleverd bij de machines 1 accu 4,0 Ah na online registratie

**PROMO**  
BL4040



LM003GM102

LM004GM102



**PROMO**  
E-08458



GRATIS  
Gereedschapsset



DUC256Z001

DUC256Z001

DUC356Z001

DUC406Z001

DUC306Z001

**PROMO**  
831253-8



GRATIS  
Opbergtas



UM600DSAEX

DUM604RFEX

DUM111SYX



DUM604ZX

Bij aankoop van een 40Vmax machine hieronder

Gratis promo na online registratie

**PROMO**  
AS001GTZ



GRATIS  
Blaas- en zuigmachine

UC003GM101 UC004GM101

UC002GM101 UC010GT101

UC011GT101

UC012GT102

UC013GT102



UC003GM101



UB001GM101

UB001GM101

UH007GM201

UH005GM201

UH014GM101



DG001GM105

DG001GM105

UH004GM201

UH006GM201

UH013GM101

UH007GM201

UH004GM201

**PROMO**  
DMR057



GRATIS  
Lantaarn met  
radio en  
Bluetooth



DUH501RTE

DUH501RTE

Deze XGT machines  
worden geleverd met  
batterij(en) en lader



**Ontvang een gratis cadeau!**

Van 01 januari 2024 t.e.m. 31/12/2024 kan u bij aankoop van de bovenstaande producten een gratis cadeau aanvragen! Voor de gratis producten na online registratie: surf naar [www.makita.be](http://www.makita.be) en vul het formulier in dat u kan terug vinden in 'Mijn Makita'. Na ontvangst van de correcte gegevens sturen we het gratis product zo snel mogelijk naar u toe.

De actie is uitsluitend van toepassing op aankopen bij een officieel erkende Makitaverdeler. Deze kan u terugvinden in de dealerlocator op [www.makita.be](http://www.makita.be). De complete voorwaarden van deze actie zijn na te lezen op de actiepagina in 'Mijn Makita'. Actie niet cumuleerbaar met andere acties en niet van toepassing op machines die deel uitmaken van een combikit of een omruiling in het kader van een reparatie.



**DLX4181PT2**  
ACCU COMBOPACK TUIN

36V

**18V**  
LITHIUM-ION



**DLX4181PT2**

Bijgeleverde accu's	2 x accu 5,0 Ah
Duo snellader	DC18RD
Heggenschaar	DUH507
Bladblazer	DUB184
Gastrimmer	DUR193
Grasmaaier	DLM432
Prijs in €	excl. btw
	incl. btw

**DLX5057PTJ**  
ACCU COMBOPACK TUIN

36V

**XPT**  
EXTREME PROTECTION TECHNOLOGY

**BL**  
MOTOR

**18V**  
LITHIUM-ION



**DLX5057PTJ**

Bijgeleverde accu's	4 x accu 5,0 Ah
Duo snellader	DC18RD
Heggenschaar	DUH601
Kettingzaag	DUC353
Gastrimmer	DUR368
Grasmaaier	DLM460
Bladblazer	DUB362
Prijs in €	excl. btw
	incl. btw